

# PUZZLE CRAFT

By Stewart T. Coffin

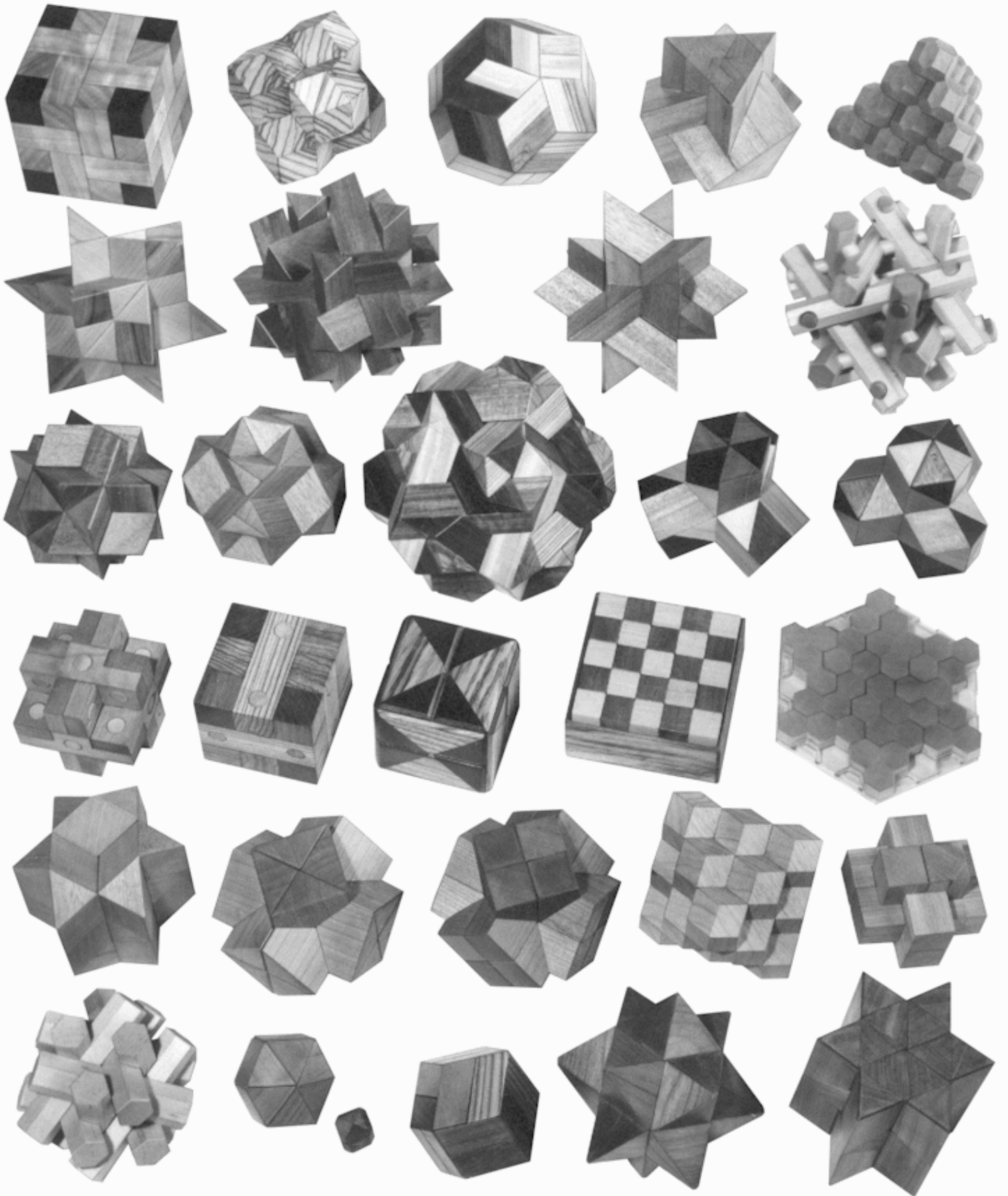

PUZZLE CRAFT

1985 Edition

- Part 1 - Mechanical and Geometrical Puzzles, Bibliography, Sources, Patents, Topological, Dissection, and Combinatorial Puzzles.
- Part 2 - Burrs and Polyhedral Puzzles, Solid Dissections, Polyhedral Blocks, Design Considerations, Theory, and Suggestions.
- Part 3 - Woodworking Techniques, Sawing, Drilling, and Gluing Using Special Jigs, Puzzle Making as a Home Business.
- Part 4 - A Compendium of 80 New and Original Puzzle Designs - A Reference Guide for the Collector, Designer, or Maker.

Compiled, published, and copyrighted by:

Stewart T. Coffin  
79 Old Sudbury Road  
Lincoln, MA 01773

-----

Puzzles shown on cover:

- Top row - Convolution, Improved Cluster-Buster, Design No. 72, Triangular Prism, Four-Piece Pyramid.
- Second row - Twelve Point, Broken Sticks, Third Stellation, Locked Nest.
- Third row - Second Stellation, Scrambled Scorpius, Jupiter, Hexagonal Prism, Augmented Four Corners.
- Fourth row - Frantix in modified version, Corner Block, Diagonal Cube, Unhappy Childhood, Snowflake in wooden version.
- Fifth row - Star-of-David, Three Pairs, Squareface, Octahedral Cluster, a typical standard six-piece burr.
- Bottom row - Hexsticks, variation of Pennyhedron, truncated Minihedron, Garnet, Split Star, Queer Gear.

These are representative samples of some of the 100-odd puzzles described in Puzzle Craft.

## Preface to the 1992 Edition

*Puzzle Craft* was begun in 1974 as a newsletter of very limited circulation having to do with mechanical and geometrical puzzles, especially those which could be made in the classroom or shop. It started out as an adjunct to my cottage industry (presently discontinued) of designing and making wooden puzzles. It first appeared in rough book form in 1984, with an improved edition in 1985.

In 1990, a sequel to *Puzzle Craft* titled *The Puzzling World of Polyhedral Dissections* was published by Oxford University Press. There was considerable duplication of puzzles between the two books. In this entirely new edition of *Puzzle Craft*, I have attempted to correct that situation by including many new designs never before published. In cases where the same puzzle is described in both books, the emphasis in this book is on woodworking, whereas the companion Oxford book has more to do with geometrical recreations.

Furthermore, this new edition is slanted more towards puzzles that are relatively easy to make, some even without power tools. By the same token, most of these puzzles have few pieces and are not fiendishly difficult to solve, as I have always maintained that it is the simpler puzzles which have the greater appeal. Some are so simple that assembly directions are unnecessary. Some have multiple solutions, with one solution being shown and the others left for the reader to discover. Included also are a few more difficult puzzles - *with* solutions!

Some leftover 1985 covers are being used to bind this edition also, while they last. This edition, like the previous ones, is produced by duplicating the pages at our local copy center and binding them right here in my shop as orders trickle in. This allows changes and additions to be made quickly and easily, as new ideas or long forgotten old ones continue coming to light in the dim and dusty recesses of my workshop. All puzzles described in this edition are my own original designs unless indicated otherwise.

Thanks to Margie, who assisted in the preparation and typesetting of this edition, and to the many others who contributed in some way or other.

Copyright: February 1992  
Stewart T. Coffin  
79 Old Sudbury Road  
Lincoln, MA 01773



## Contents

Chapter 1 - <b>Flat (Two-Dimensional) Dissection Puzzles</b>	5
Modified Five-Piece Puzzle, making in plywood, Tangram, Quadrilateral Puzzle, Sam Loyd Puzzle, making a tray, two-sided tray, other projects.	
Chapter 2 - <b>Flat Building Block Puzzles</b>	12
Nine-Piece Square Puzzle, Cornucopia Puzzle, Rhombic Block Puzzle, hexagonal block puzzles, Snowflake Puzzle.	
Chapter 3 - <b>Solid Block Puzzles</b>	20
Abbie's Puzzle, Pentominoes, Joined Pairs Puzzle, Split Cube Puzzle, Half-Hour Puzzle.	
Chapter 4 - <b>Interlocking Block Puzzles</b>	26
Five-Piece Solid Block Puzzle, Convolution Puzzle, Three-Piece Block Puzzle.	
Chapter 5 - <b>Burr Puzzles</b>	30
Burr No. 305, Cutler's L5 Notchable Burr.	
Chapter 6 - <b>Burrs with Pins and Holes</b>	32
Frantix Puzzle, Pin-Hole Puzzle, Corner Block Puzzle.	
Chapter 7 - <b>Diagonal Burrs</b>	35
Six-Piece Diagonal Burr, diagonal saw jig, Star Puzzle, Four Corners Puzzle.	
Chapter 8 - <b>Puzzles with Polyhedral Blocks</b>	40
Peanut Puzzle, Eight-Piece Cube Puzzle, Four-Piece Pyramid Puzzle, Octahedral Cluster Puzzle, edge-beveled cubes, Distorted Cube Puzzle.	
Chapter 9 - <b>Puzzles That Make Different Shapes</b>	47
Triumph Puzzle, Fusion-Confusion Puzzle, Star of David Puzzle.	

Chapter 10 - <b>Pennyhedron and Garnet Puzzle Families</b>	52
Pennyhedron Puzzle, Pennydoodle Puzzle, Fourth Dimension Puzzle, Garnet Puzzle, Thirty-Sided Puzzle.	
Chapter 11 - <b>Square Prism Puzzles</b>	57
Square Prism Puzzle, Three Pairs Puzzle.	
Chapter 12 - <b>Triangular Twelve-Piece Burr</b>	59
Twelve-Piece Separation Puzzle.	
Appendix - <b>Woodworking Techniques, Notes.</b>	61

## Chapter 1 - Flat (Two Dimensional) Dissection Puzzles

Most readers of this book are probably interested in actually making puzzles, not just reading about them. So let's skip the usual introductory remarks and get started straightaway. Much useful general information will be sprinkled in amongst the various projects, so better not skip too far ahead without at least reading the intervening material. Additional woodworking tips will be found in the Appendix.

### Modified Five-Piece Puzzle

This 1989 puzzle design is my modified version of a popular five-piece dissection of the square by famous puzzle inventor Sam Loyd. It is probably the simplest puzzle in this edition, both to make and to solve, but don't underrate it on that account. Not only are simpler puzzles usually more fun to play with, but they often contain some surprising and long overlooked subtleties for added recreations.

Start with a sheet of fine, smooth cardboard such as Bristol board or posterboard at least four inches square. It should be the same on both sides and as heavy as can be cut easily and accurately with knife or scissors. "Cardboard!" exclaims the reader. "But wasn't this supposed to be a book for woodworkers?" There are several reasons: Cardboard is quick and easy, so best for making experimental models. I use them all the time. You may not wish to make every puzzle in this book finely crafted in wood, so cardboard models let you work out solutions and decide which are your favorites. Furthermore, an accurate cardboard model serves as a template for making the puzzle in wood, as will be explained shortly.

On this cardboard, lay out a square of any size you wish. Many woodworkers, accustomed to working only from dimensioned drawings, may be dismayed to find numerous plans in this book lacking dimensions. They are omitted whenever they are considered to be superfluous. These puzzles are all based upon geometrical principles, which are inherently dimensionless. Adding dimensions would only obscure and unnecessarily complicate the elegant geometrical simplicity of the idea. Furthermore, you may scale the puzzle up or down to any size you wish to suit your particular requirements. But for a start here, if you want a suggestion, make it four inches square. Locate the midpoints of three sides, draw diagonal construction lines from them to the corners, and cut out the pieces as shown on the next page.

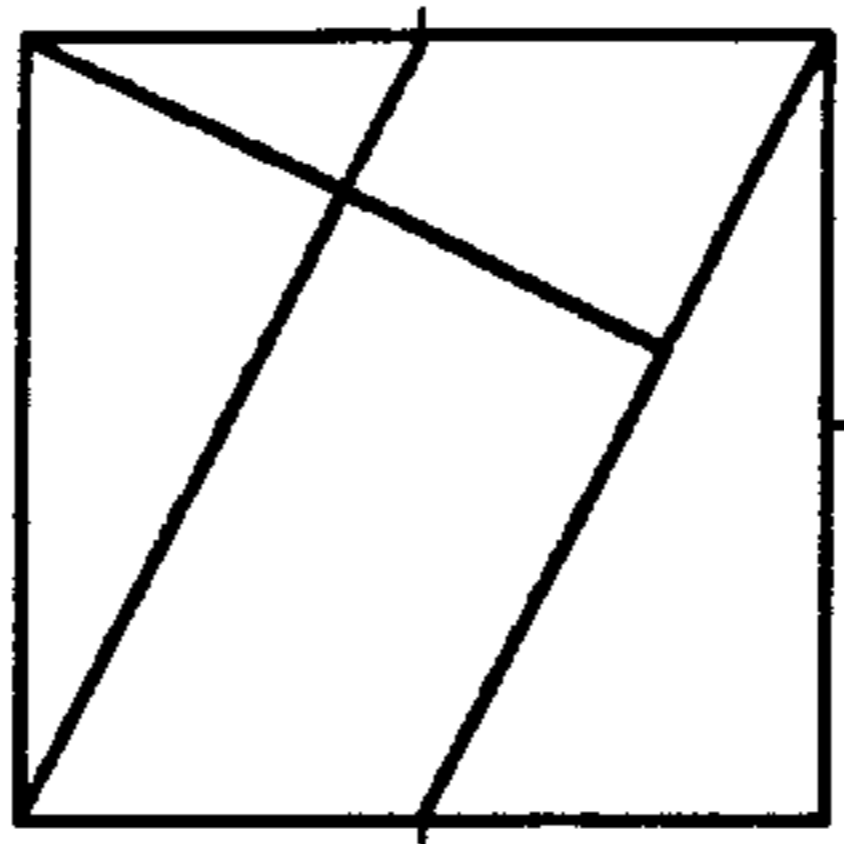

The object of the puzzle is to scramble the pieces and reconstruct the square (quite easy) or to construct various other problem shapes shown below. In puzzles of this sort, it is understood that all of the puzzle pieces are to be used for each solution unless indicated otherwise. For further recreation, you can tinker with the pieces to invent your own original problem shapes. Compile a booklet of them and think up imaginative names for them. By the way, young children are especially good at this. How many convex figures are possible, a convex shape being one without any holes or inside corners?





## Making Flat Dissection Puzzles in Plywood

You will soon be able to tell if your cardboard pieces are accurately cut, as you fit them together different ways. Accuracy is stressed throughout this book. Crude models are all right for experimental work, but accurately made wooden puzzles are ever so much more satisfying to play with, and of course also more suitable as gifts. It is rather like listening to your favorite music. The melody may always be recognizable, but it sounds much more pleasing when all the parts are in perfect harmony with one another.

An accurately made set of cardboard pieces may be used as templates for laying out the puzzle pieces on plywood, tracing with a sharp pencil. I recommend plywood over plain thin lumber for two reasons. A board of tough hardwood may be strong enough for most puzzle piece shapes, even in 1/4-inch thickness, but plywood pieces of that thickness are virtually unbreakable. More important, plywood is much more dimensionally stable. To illustrate this, refer to the drawings below. The popular seven-piece dissection of the square known as Tangram was laid out accurately on thin lumber with typical summertime humidity. Then, after drying and shrinkage, greatly exaggerated here for purpose of illustration, the puzzle was reassembled as shown. The principle is still there, but much of the aesthetic charm has been lost.

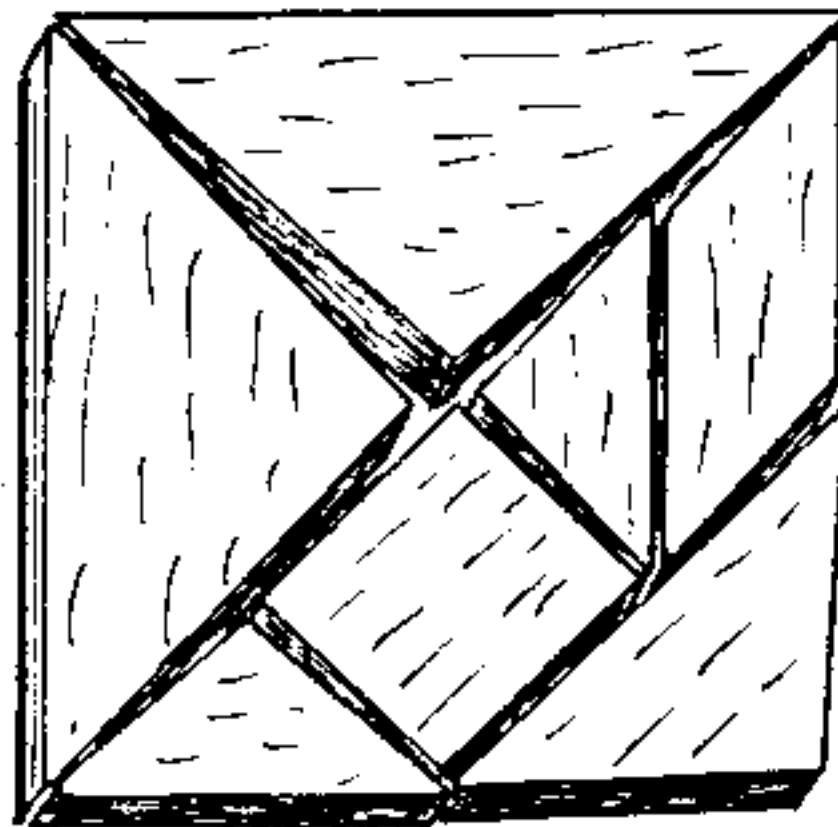
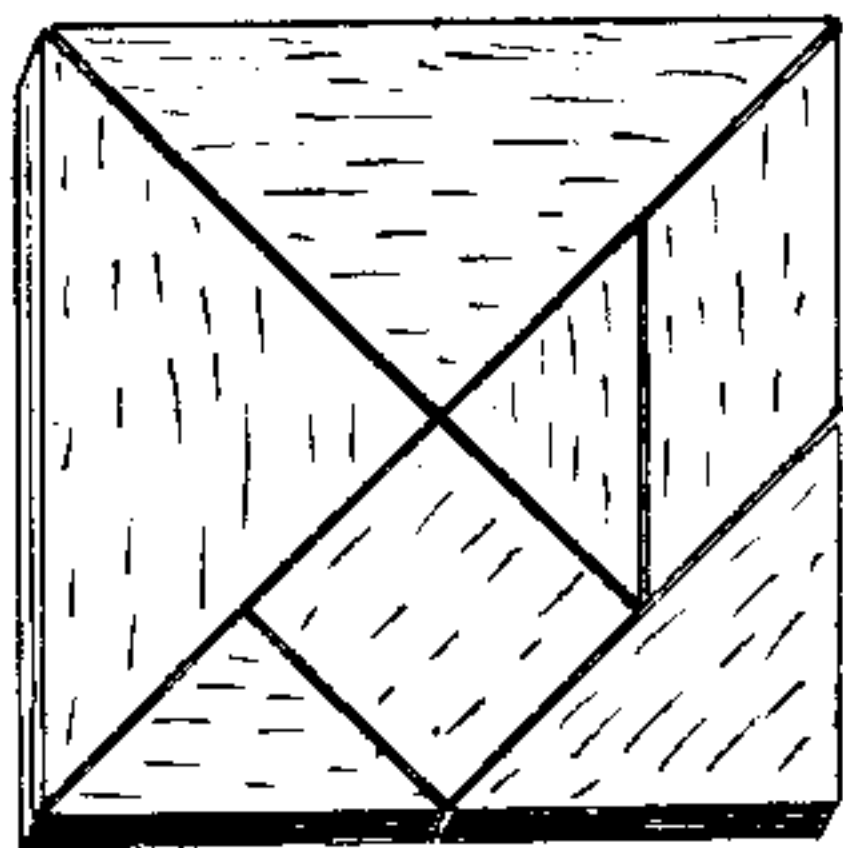

Quarter-inch mahogany (Luan) plywood, available in building supply stores, is acceptable for a starter as long as it is the same on both sides. Much better is cabinet grade plywood sold by hobby and woodcraft shops and mail order suppliers. One type is called Baltic Birch. It is a solid laminate of thin plies of hardwood throughout, without knots or voids. Thicker pieces tend to be more pleasing, so for your favorite projects, consider 3/8-inch or even 1/2-inch thickness. For your better puzzles, you may also want a tray to hold them. Directions for trays are given a couple pages ahead.

## Quadrilateral Puzzle

This puzzle was developed in 1989 and is here published for the first time. To lay out this puzzle on cardboard, again start with a square. Locate the midpoints of all four sides. Draw diagonal construction lines from these to the corners. Now add one horizontal bisecting line, as shown below. Then cut out the seven puzzle pieces as shown.

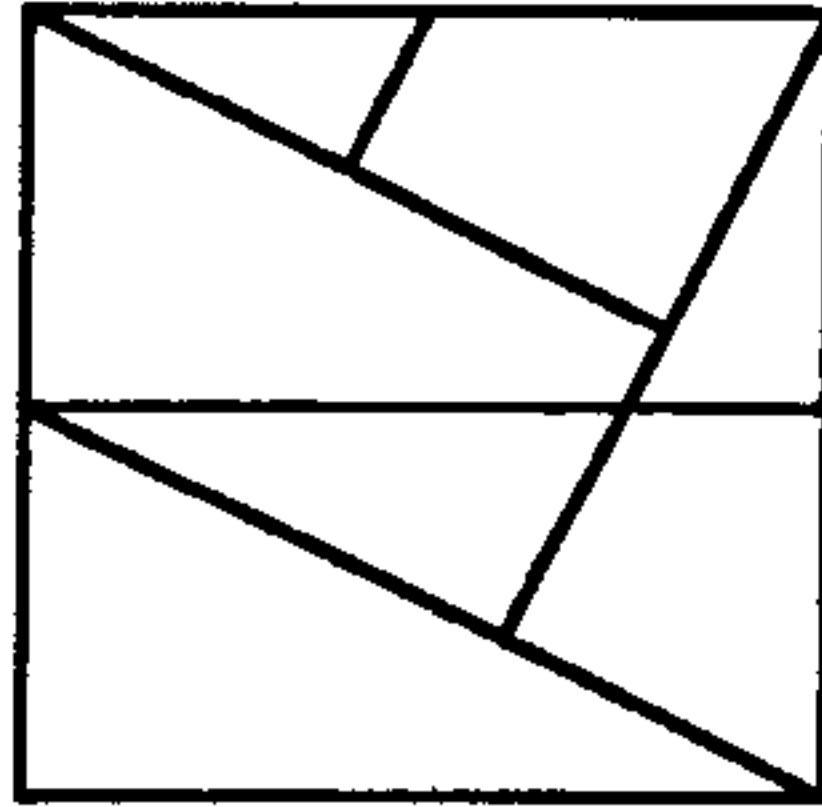

The object of this puzzle is to assemble all seven pieces to form various four-sided shapes (quadrilaterals) as many ways as you can. The 28 known shapes are shown below, but their solutions are left for you to figure out. Some of them differ from each other only slightly, so you will have to examine them closely. Now you will see why accurately made puzzle pieces are so important. Most of them have multiple solutions. For added recreation, you can see how many of these you can discover on your own without referring to the diagrams. Are any other quadrilateral shapes possible? I may have missed some. You might also try triangular or five-sided shapes.

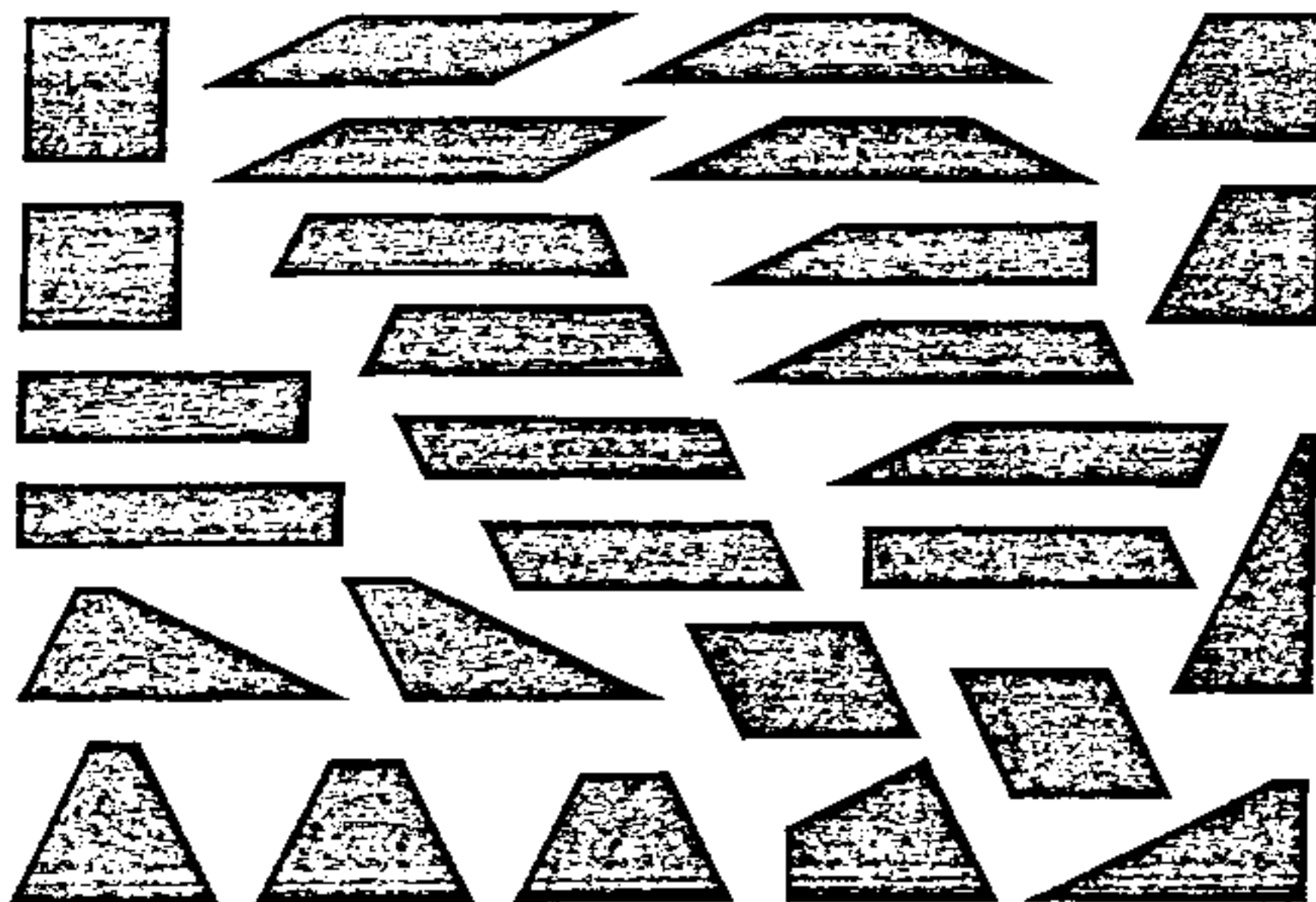

The Quadrilateral Puzzle is presently being made and sold by Trench Enterprises, Three Cow Green, Bacton, Stowmarket IP14 4HJ, England. For construction of this puzzle in wood, see woodworking tips a couple pages back.

Why the extra step with cardboard, you may wonder. Why not instead simplify matters by laying it out directly on plywood and then sawing carefully along the center of each line? One objection to this approach is that the grain pattern of the wood may reveal the solution and make it too easy. An even more serious problem is illustrated by the drawings below, again greatly exaggerate for purpose of illustration. The Sam Loyd Puzzle was laid out accurately on the plywood, then sawn on a table saw with the cut accurately centered on each line. When reassembled tightly, note the errors introduced by the kerf (width of cut) of the saw.

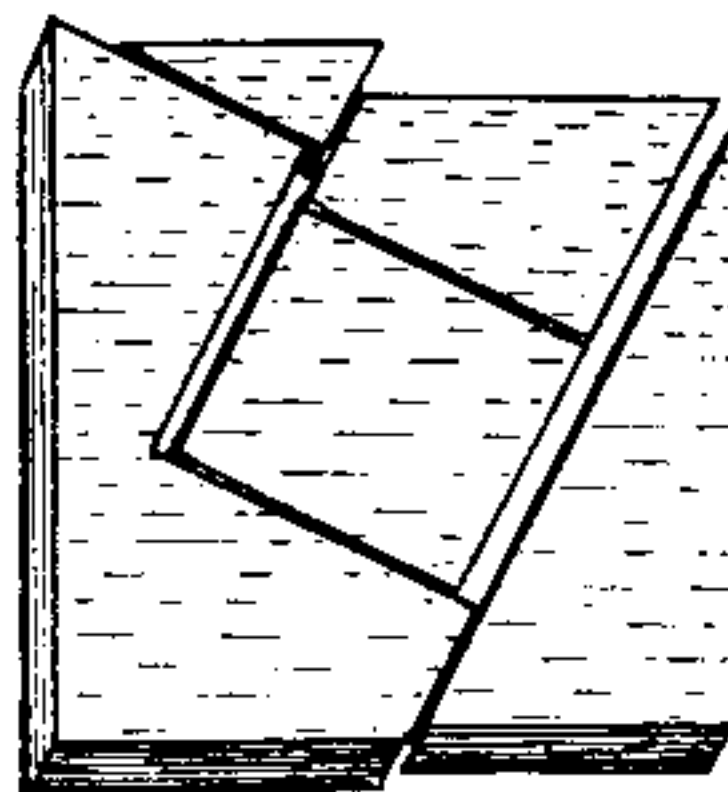
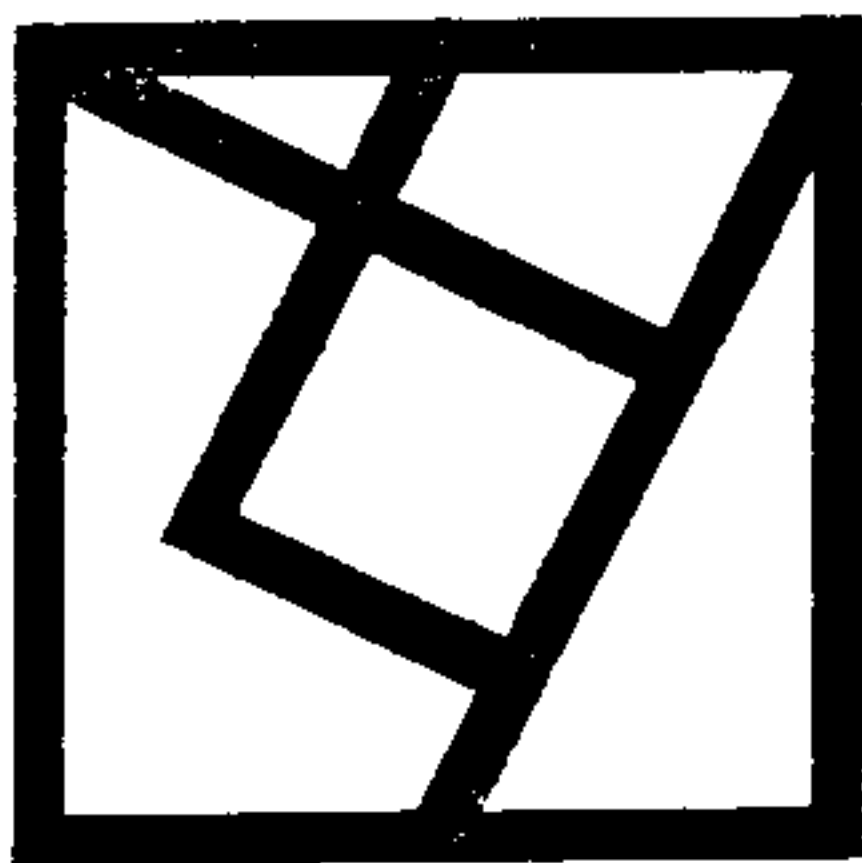

By the way, note also that one of the pieces of the Sam Loyd Puzzle contains an inside corner. This creates special problems with the table saw, and for that reason I tend to avoid using such pieces.

### **Making a Tray**

An optional project with any of these flat dissection puzzles is to make a shallow tray to contain the assembled puzzle. When the puzzle makes many different shapes, you have a choice likewise in shape of tray to hold it, but let us assume a square tray as the most obvious choice.

For a simple tray, just glue shallow rails with mitered corners onto a square plywood base, as shown on the next page. Don't make it too tight, but rather leave about 1/16-inch of play, as this makes the pieces easier to manipulate. If an instruction sheet comes with the puzzle, perhaps it can be folded and trimmed to fit neatly inside the tray underneath the puzzle pieces.

Top and side view of tray:

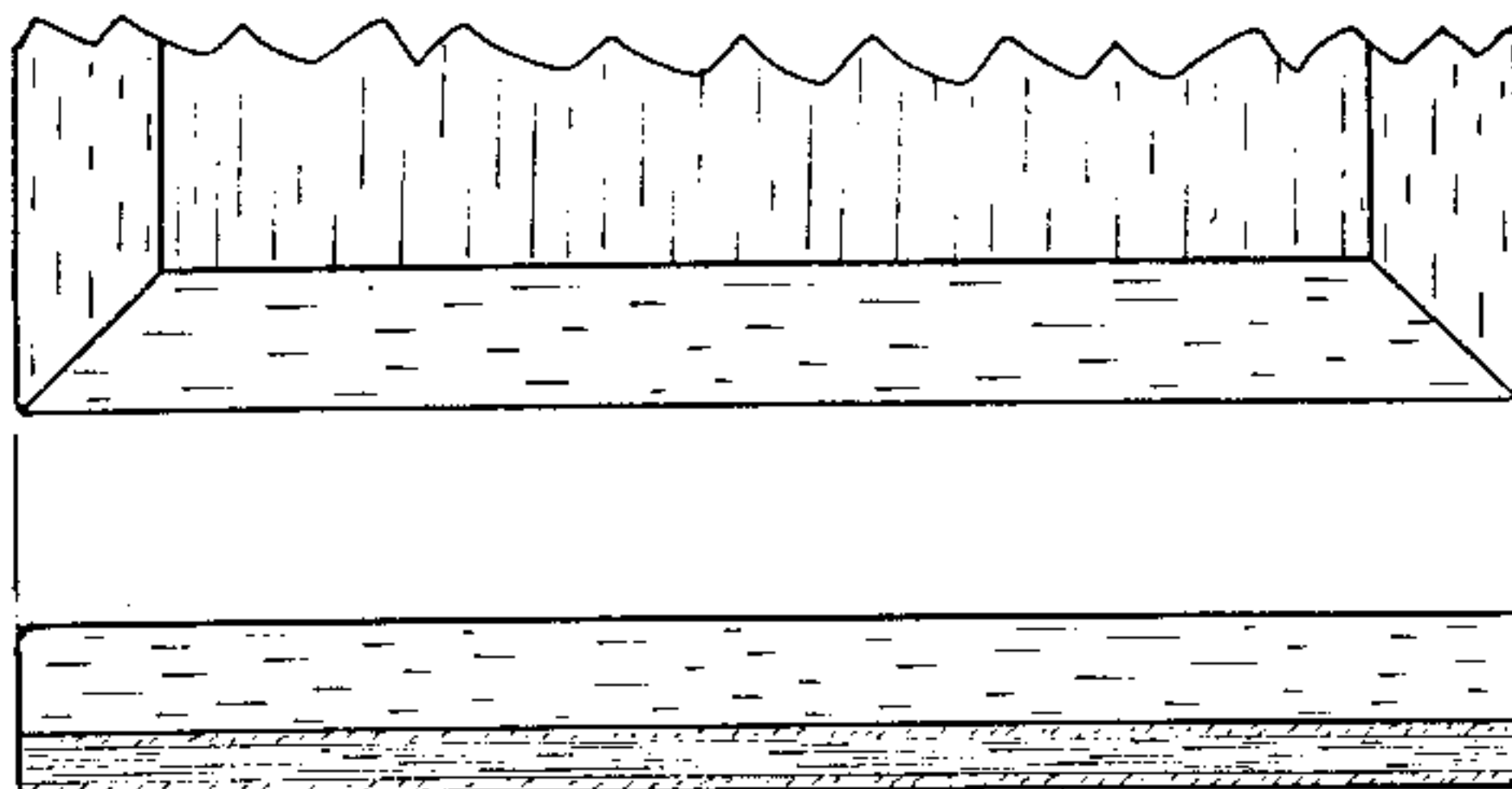

Yet another option is to add a cover, practically identical to the tray. The rails of both the tray and cover are slightly shallower than the puzzle pieces are thick. Thus, if the puzzle pieces are  $\frac{3}{8}$ -inch thick, make the tray and cover each  $\frac{1}{4}$ -inch deep. This allows room for an instruction sheet. See illustration below.

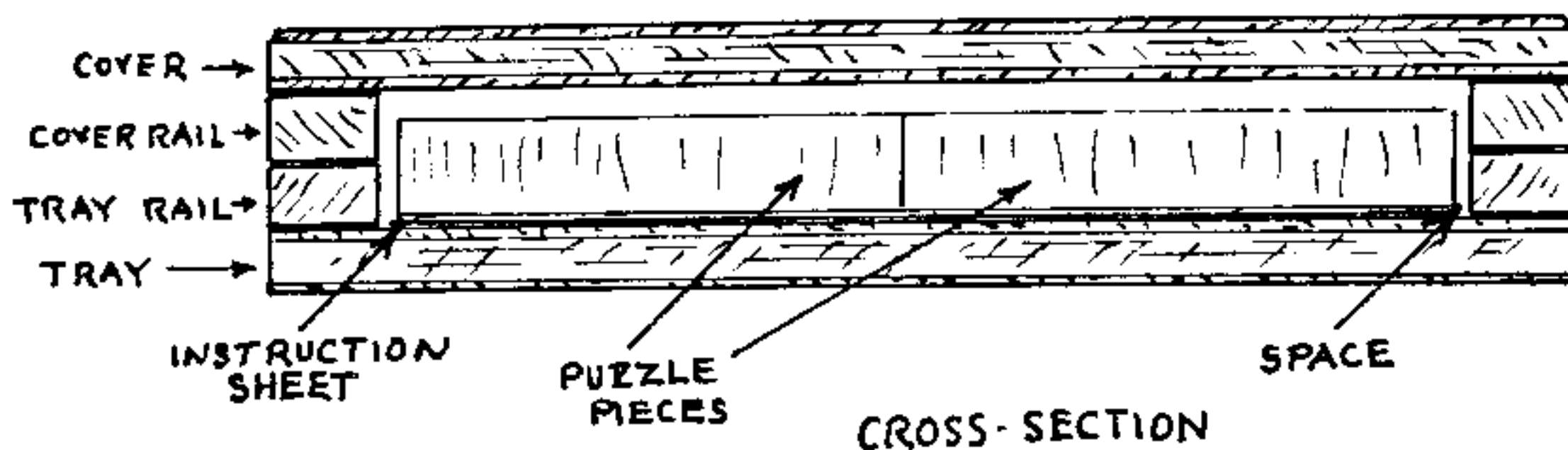

### An Optional Two-Sided Tray

The square dissection puzzles described thus far can also be assembled to form various rectangles. This suggests the possibility of using a two-sided tray for the puzzle, square on one side and rectangular on the other. If the square solution is 4 x 4 inches, then one of the rectangular solutions will be approximately 3- $\frac{1}{2}$  x 4- $\frac{1}{2}$  inches. Plans for such a tray are shown on the next page. This tray is especially suitable for use with the Modified Five Puzzle.

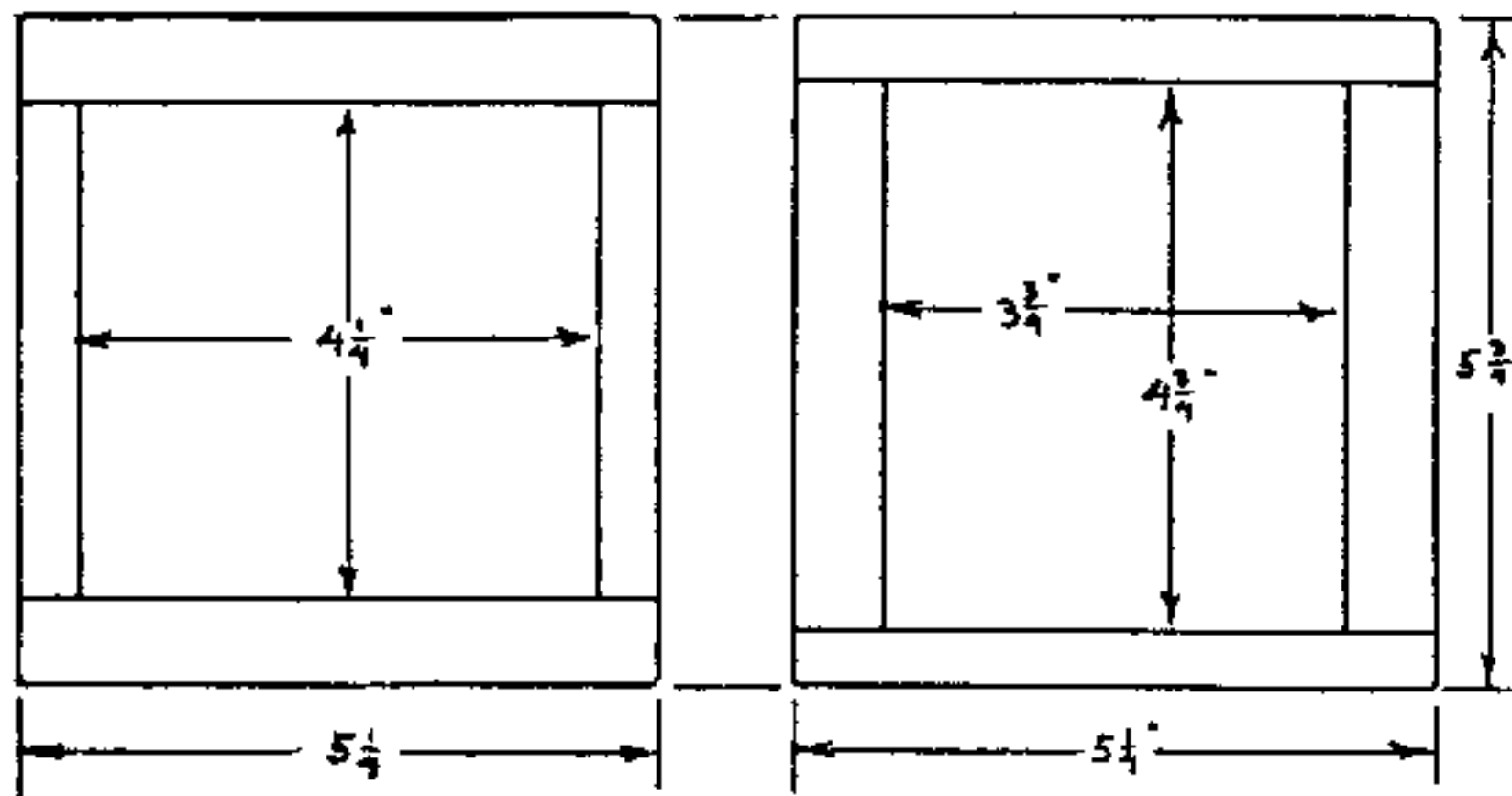

### Other Projects for the Curious Puzzle Maker

We conclude this chapter with some suggestions on how you can invent your own dissection puzzles. In the drawing below, diagonal construction lines have been drawn from the midpoints of all four sides of the square to the four corners, with a horizontal and vertical line added for good measure, dividing the square symmetrically into 16 sections.

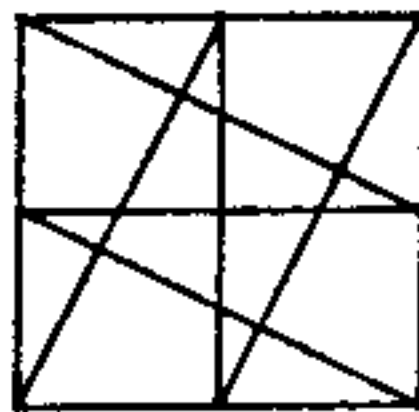

Note first of all that these construction lines are more than sufficient for constructing the Modified Five-Piece Puzzle, the Sam Loyd Puzzle, and the Quadrilateral Puzzle. You could cut out all 16 pieces and consider that a puzzle of sorts, but the large number of pieces, identical in quadruplicate, lack that intangible element of novelty and simplicity that most good puzzle designs have. The process, then, is to combine these sections into practical puzzle pieces. You can do this on paper by erasing some of the line segments, or with cardboard models by taping the sections together. The design possibilities here are virtually limitless. Around five to seven would seem to be about the optimum number of pieces. Try to have all pieces dissimilar. A few samples are shown below, but readers are encouraged instead to invent new and original ones of their own. Then compile a booklet of problem shapes to accompany them. Attractively made, with instructions, tray and cover, what a delightful and original gift!

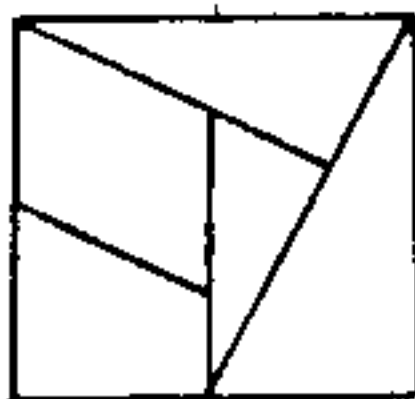

5

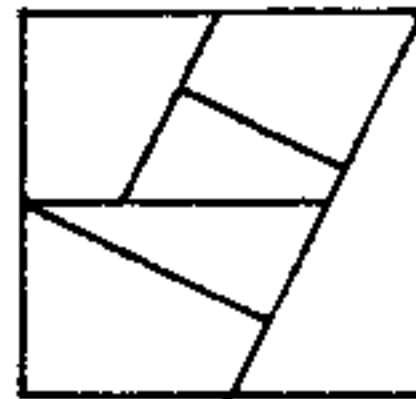

6

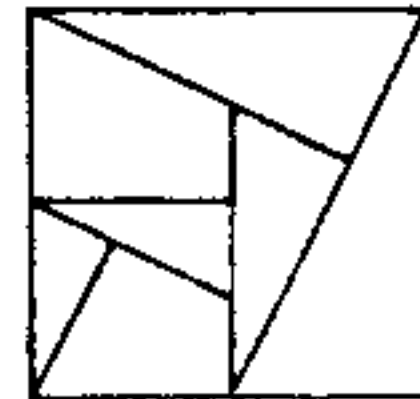

7

## Chapter 2 - Flat Building Block Puzzles

The puzzles to be considered next are similar in principle to those of Chapter 1, but instead of being created by cutting up a geometrical shape into pieces, the puzzle pieces are built up of identical building blocks joined together different ways. Usually all of the puzzle pieces are dissimilar. By far the most popular shape for the building blocks is a square.

### Nine-Piece Square Puzzle

This new (1989) design consists of nine puzzle pieces that assemble to form a square. Such so-called "checkerboard" puzzles abound in the literature. If you prefer, you can invent your own. This particular design was the result of considerable trial and error to achieve certain objectives and one novel feature. The nine pieces are all dissimilar and non-symmetrical, and they assemble one way only. The novel feature is that if three different colors of wood are used for the puzzle pieces, three of each color, no like colors touch each other in the assembled puzzle, creating an attractive mosaic tile pattern. If you think that is easy, try to find another!

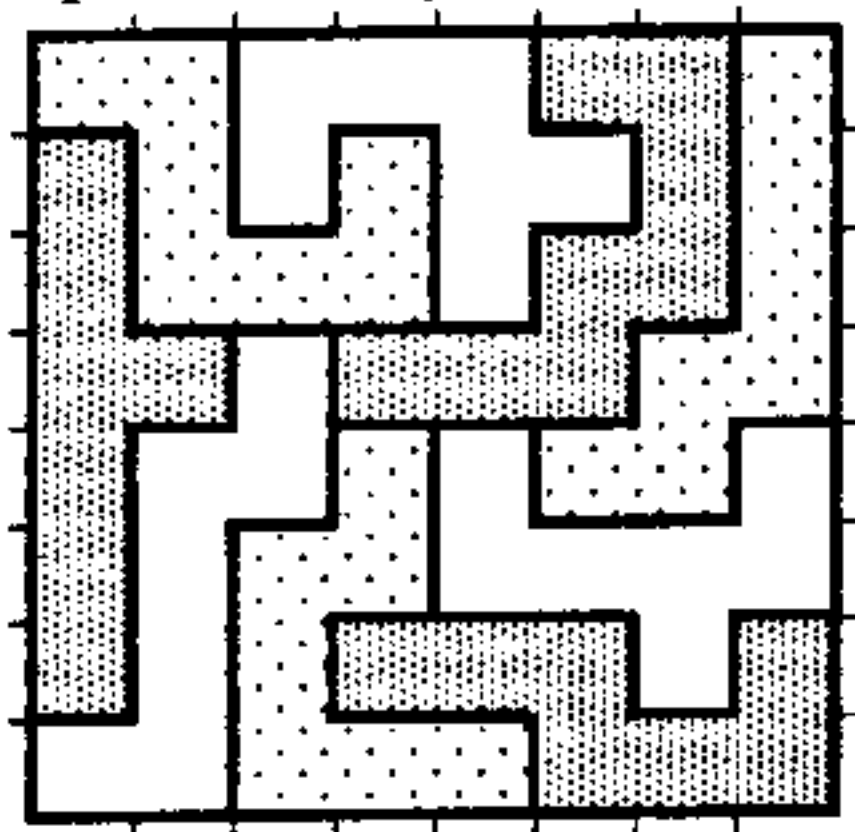

To make this puzzle, and all others of this sort, start with accurately milled square stock, kiln dried, of a not too grainy hardwood such as maple, cherry, mahogany, or walnut. For this puzzle, 3/4-inch square is a good size. Check it very carefully for uniformity and accuracy, both width-wise and angular. This is critical. Cross-cut it on a table saw into uniform square blocks, say 1/2-inch thick. With the right kind of fine-tooth so-called "plywood" blade, you should get a smooth saw cut requiring practically no sanding.

Care should be taken to glue the blocks together accurately. This is not as easy as you might suppose, and is a good practice exercise for other more demanding projects further on. Before gluing any, hold them all tightly together in their exact square assembled form and make sure they all fit together accurately. If using three dissimilar woods, check to make sure you have got the colors right. Then start gluing the blocks together one by

one while still holding them together in this assembly. Bits of waxed paper can be used to prevent accidental glue joints with adjacent pieces.

The puzzle pieces can be sanded lightly top and bottom on a belt sander or by hand. Break the sharp edges slightly with fine sandpaper. Apply a finish of your choice. I prefer clear lacquer over all other finishes. I thin it at least 1:1 and apply it lightly with an artist's camel hair brush, so that it is really more of a penetrating sealer than a coating. You can wipe off that which does not soak in, or rub it down with fine steel wool when dried.

If you want to make a tray to hold this puzzle, see suggestions on trays already given a few pages back. Make it at least 1/16-inch oversized to allow for expansion of the puzzle with increased humidity.

This use of end-grain blocks in puzzles of this sort (shown below, left) is strongly recommended because it reduces the susceptibility of the puzzle to changes in humidity (as well as being easy to saw out accurately). A corresponding block with side grain (below, right) will be square at only one level of humidity, and at all others it will be rectangular, probably making this puzzle and others like it impossible to assemble. The end-grain block tends to expand and contract more uniformly in both directions.

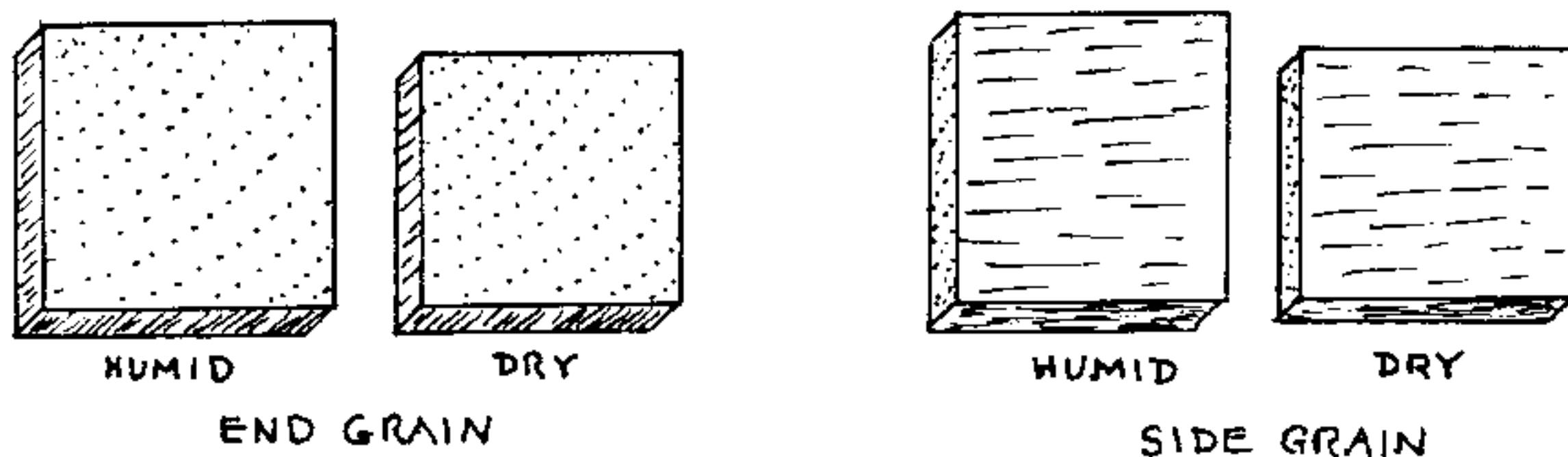

### Cornucopia Puzzle

This puzzle is no harder to make than the preceding, but much harder to solve. The prolific Cornucopia family consists of puzzles with ten pieces of six square blocks each. These fit onto an 8 x 8 checkerboard leaving four empty squares. The particular version chosen for this edition, here published for the first time, has only one solution with the four corners vacant, as shown on the next page. It also has only one solution with the four center squares vacant, left for the reader to discover. A two-sided tray is used for these two solutions. The pieces will also construct a 6 x 10 rectangle four different ways. One such solution is shown, and the others are left for the reader to be baffled by. They are hard!

Cornucopia No. 107715:

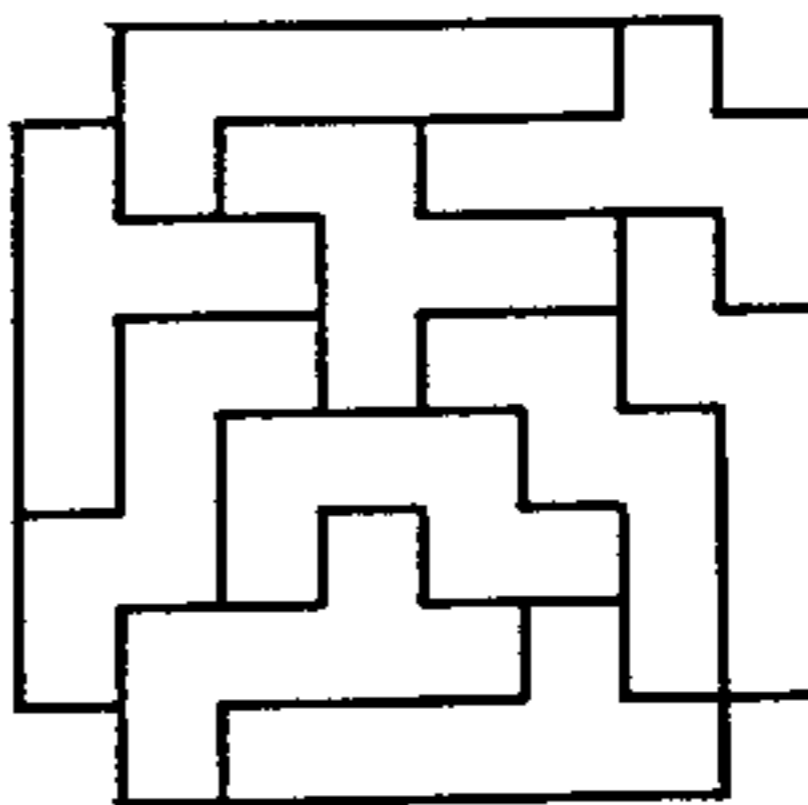

Plans for two-sided Cornucopia tray:

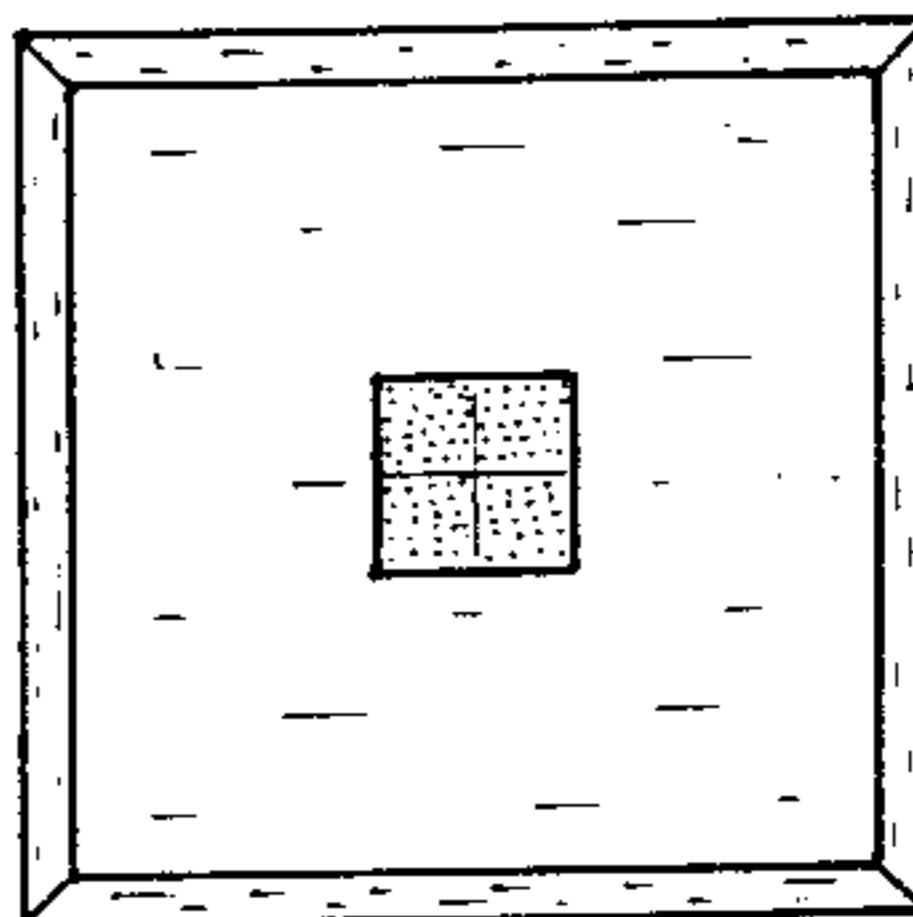
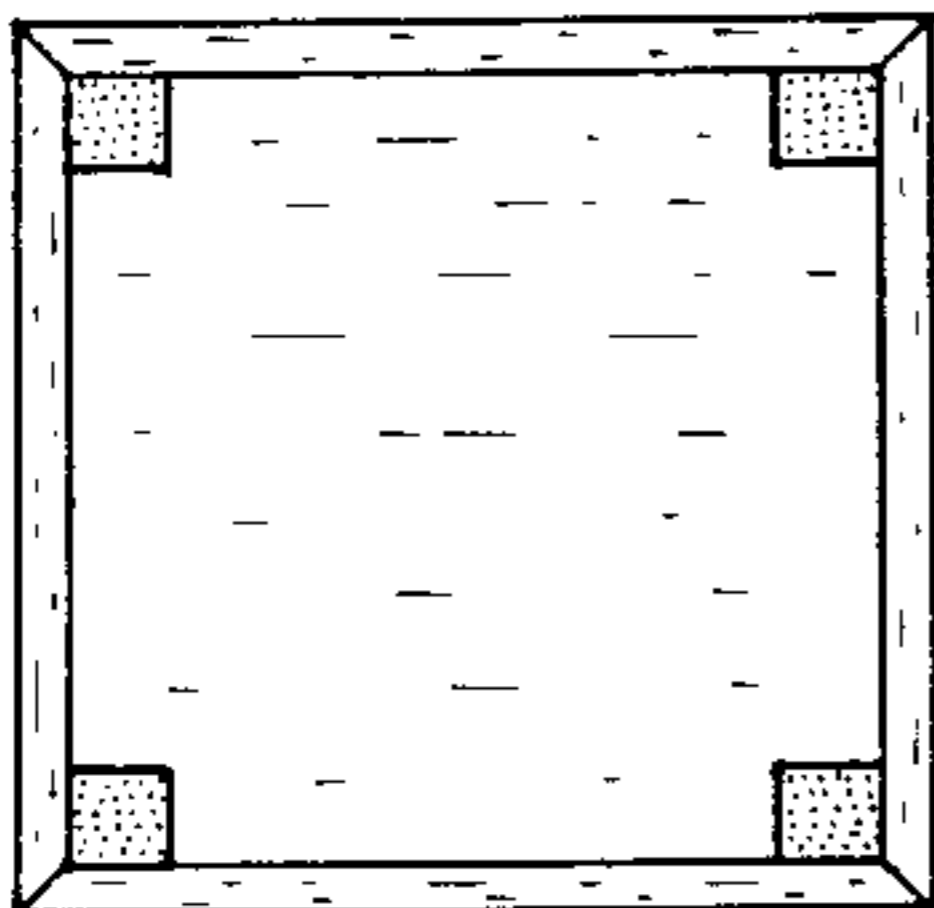

Note: This space is reserved for printing a solution to the 6 x 10 Cornucopia, when and if some reader finds one and sends it to me. So far, I have not been able to find one!

This is but a tiny sampling of the type of puzzles made up of square blocks joined together different ways. The curious reader interested in pursuing these further should be able to find many more in the puzzle literature. They are also among the most common types sold in toy stores, being easy to stamp out of cardboard or metal, or mold in plastic. Or you can invent your own.



## Rhombic Blocks Puzzle

This puzzle is mentioned in my other book, *Puzzling World*. I do not know its origin. It may have been discovered independently by others. It evolved from a family of puzzles in which the puzzle pieces are made up of equilateral triangular blocks joined different ways. In this particular version, imagine the triangles first being combined in pairs to make rhombic blocks. These rhombic blocks are then joined in threes all possible ways, resulting in nine dissimilar puzzle pieces. In order to be included in this edition, I felt it necessary to include a solution. Accordingly, I spent one long evening playing with it before finally coming up with one, shown below. There must be many others. No doubt someone will investigate them all using a computer, if not having done so already.

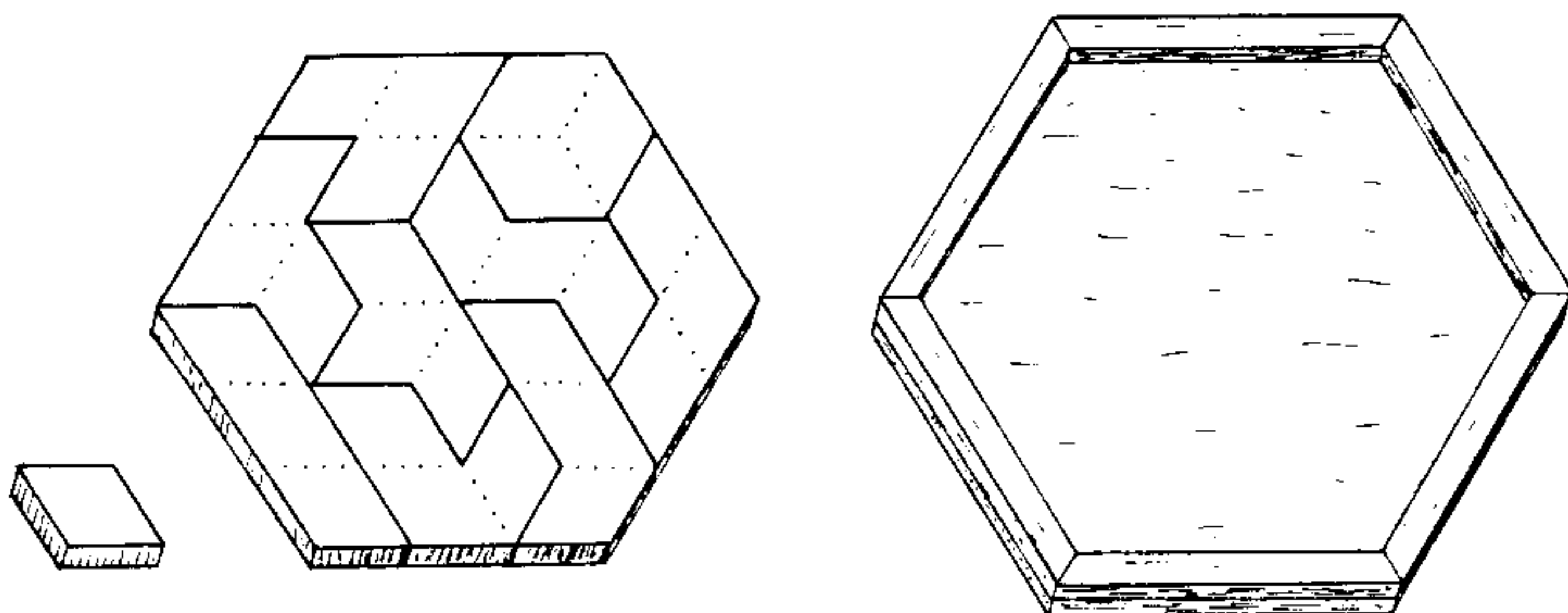

This puzzle is fairly easy to make. Start with a board at least  $\frac{3}{4}$ -inch thick, a couple inches wide and a couple feet long, as flat, uniform, and free from warp as you can find. With the table saw set at exactly 60 degrees, rip one edge. Then, again using the rip fence, make a second cut to produce a stick with rhombic cross-section. Check the dimensions carefully with calipers to make sure that they are exactly equal across the flats both ways, i.e. truly rhombic, not rhomboid. Then saw into 27 blocks about  $\frac{1}{2}$ -inch thick.

The gluing procedure follows that for the Nine Piece Square Puzzle and others of this sort. Assemble all of the blocks into the hexagonal shape, held tightly together with a rubber band, and check for accuracy of fit. Then selectively start gluing the joints. Sand and finish as before. They should fit together quite nicely. The real test comes when you start looking for other solutions. If accurately made, they should fit together well many different ways. It may take some practice.

You can make a hexagonal tray and cover to hold the assembled puzzle, following the same general methods already given in Chapter 1. Allow about  $\frac{1}{8}$ -inch of play for error and expansion.

## Hexagonal Block Puzzles

The Snowflake Puzzle, which uses 37 hexagonal blocks joined together different ways into 10 puzzle pieces, was featured in previous editions of this book. It is one of my favorite puzzles. For those who may not have access to previous editions of *Puzzle Craft* or *Puzzling World*, the plan of the puzzle pieces is shown below.

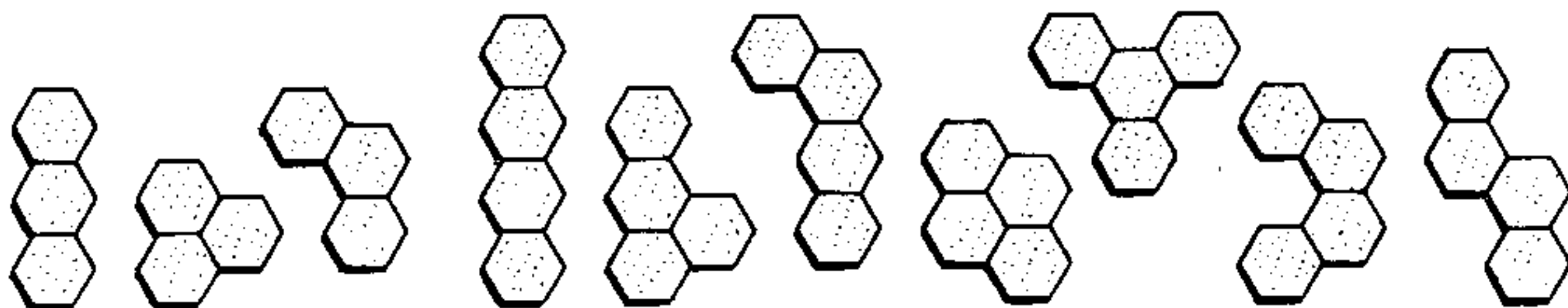

Hexagonal blocks are not nearly as easy to make accurately as square or rhombic blocks. I have published two different methods for making them, and here is yet a third way, perhaps easiest for the novice woodworker. Start with a board  $\frac{3}{4}$ -inch thick, a couple inches wide and a couple feet long, as uniform and free from warp as you can possibly find. One edge should be jointed, meaning perfectly straight and square, normally done on a jointer. With that edge against the rip fence and the table saw tilted to 60 degrees, rip the other edge at 60 degrees, turn it over and rip again, as shown. Now, with the saw still tilted to 60 degrees, lower the blade so that it cuts only halfway through, advance the rip fence exactly the correct distance such that two more cuts produce a perfect hexagonal stick. It will take some trial and error to get the adjustments just right. Measure carefully with calipers, and reject sticks with perceptible inaccuracies.

For a simpler puzzle to start with, try the one shown on the next page. It uses only 19 blocks, joined together as shown to make five puzzle pieces. Make them about  $\frac{1}{2}$ -inch thick. Assembling them into the hexagonal cluster is fairly easy. There are several solutions. If you can get them to fit accurately when assembled different ways, for a more advanced project try the beautiful Snowflake Puzzle. Some of the other figures that the Snowflake Puzzle will construct are shown on following pages.

Making a tray and cover to hold these hexagonal block puzzles is a bit more complicated than for the others with straight rail sides. One way is to trace the outline of the assembled puzzle onto plywood and saw out with a jigsaw. The version shown on the next page has a circular outside shape.

drawings for hexagonal block puzzles

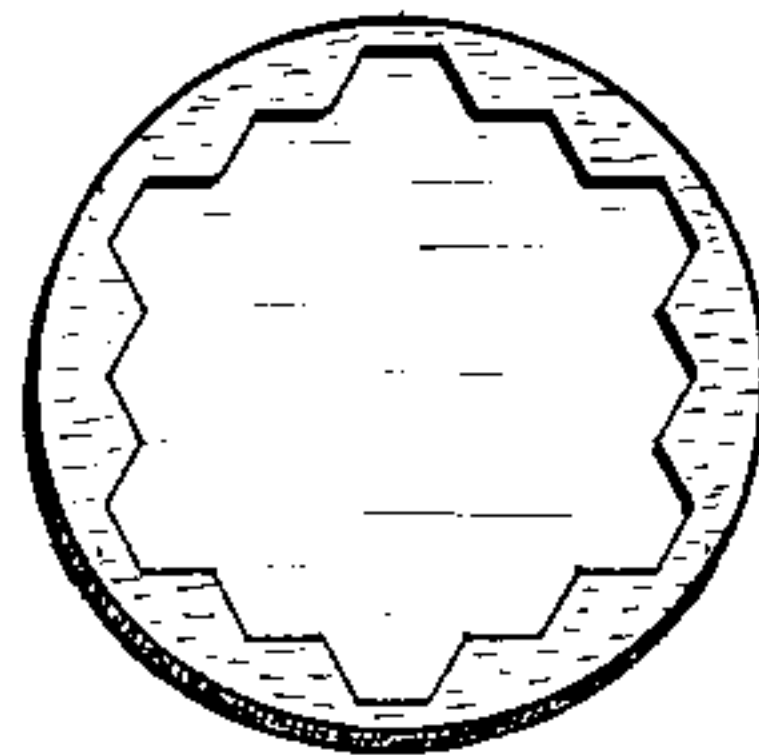
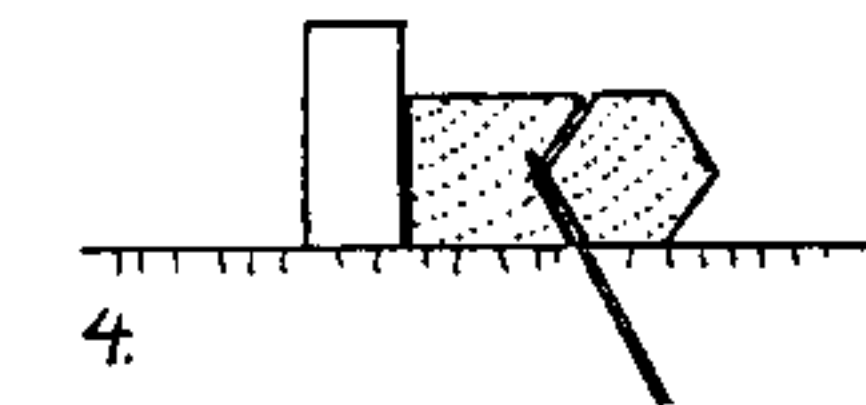
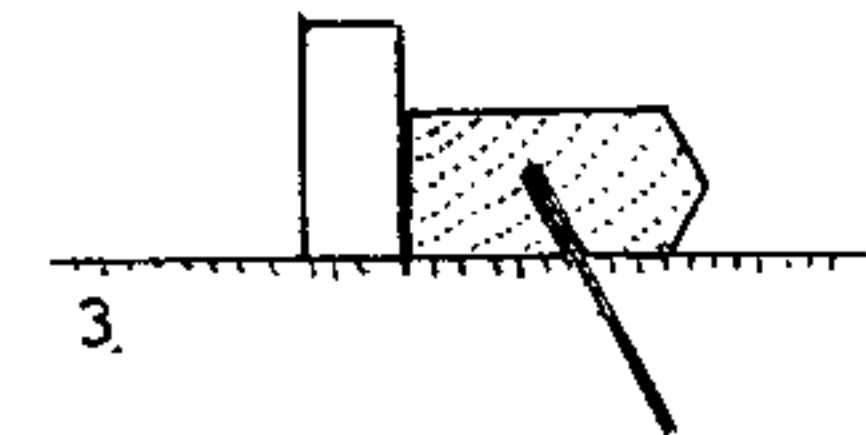
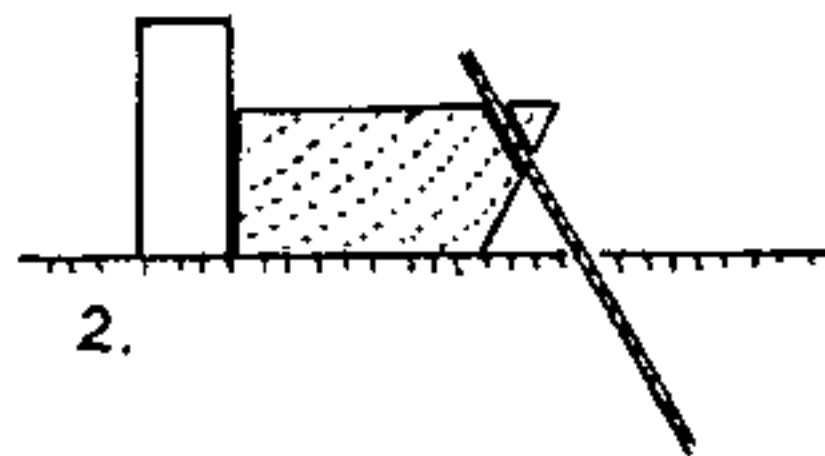
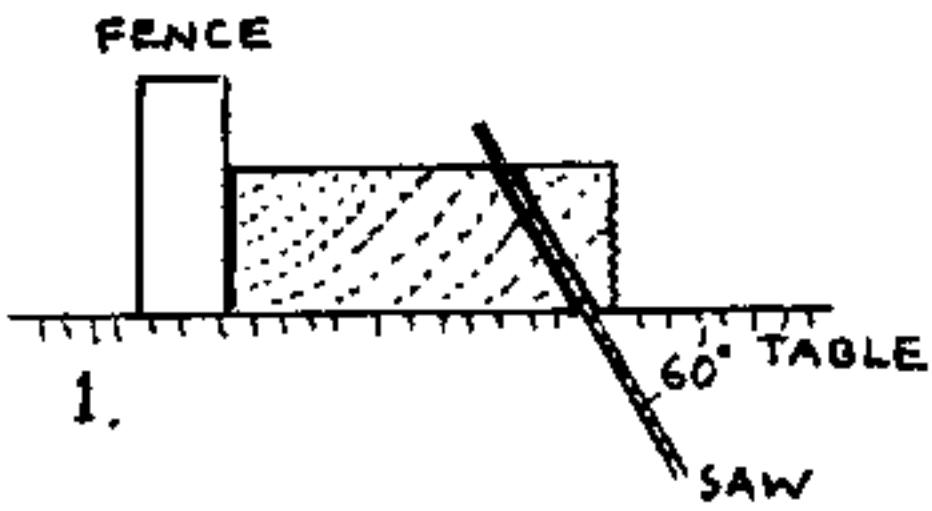
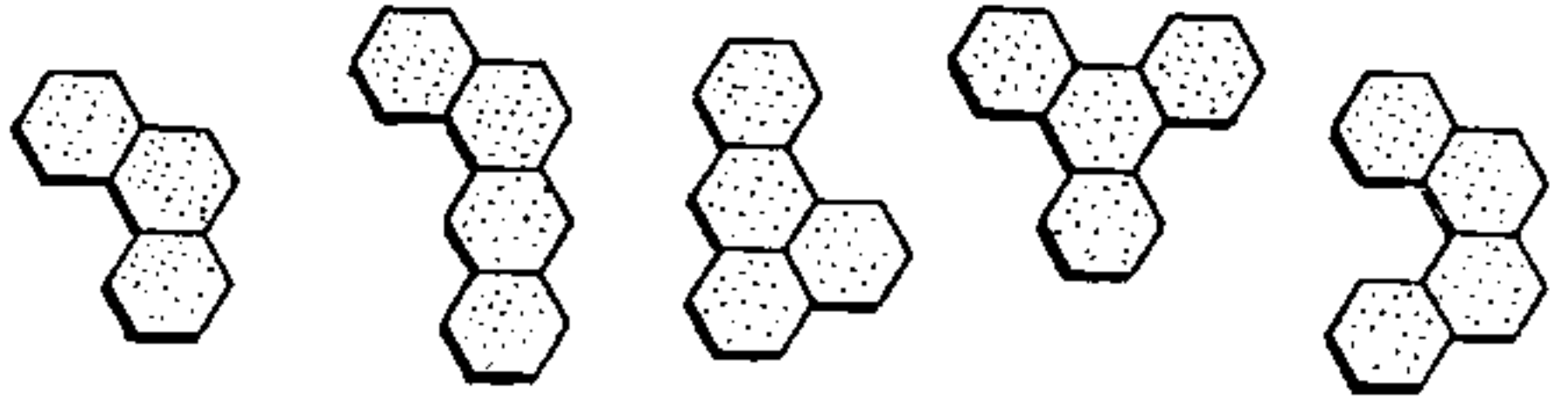
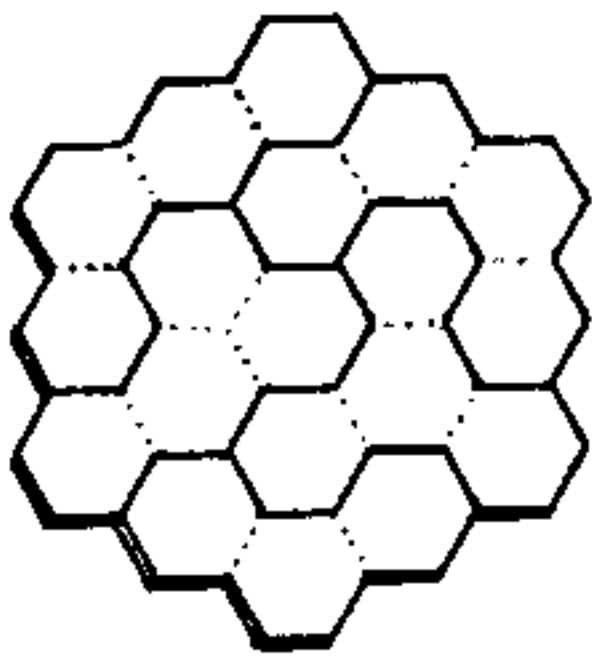

# Snowflake Puzzle

The Snowflake Puzzle was originally designed to be made in plastic. Later, a few sets were made in wood. You can use 3/4-inch hexagonal stock sawn into 1/2-inch thick blocks. Thirty-seven such blocks are glued together to make 10 puzzle pieces, as shown at left. Parts of the original 10-page instruction booklet are reproduced below and on the next page, showing some of the creative and artistic possibilities of these puzzle pieces.

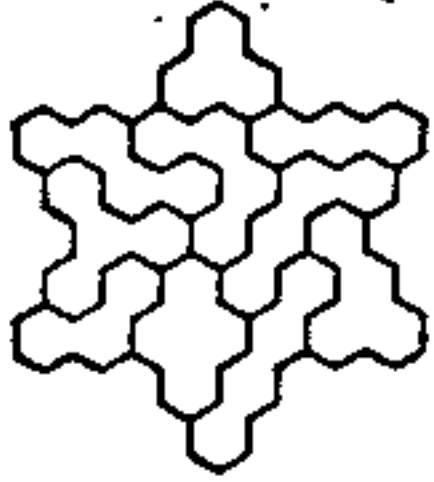

COMPLETE PATTERN

**Puzzles 3-5** - Find at least one solution for each of the three numbered triangular patterns shown below. (How many others can you find?)



**Puzzles 6-13** - Find at least one solution for each of the reflexive patterns shown below.

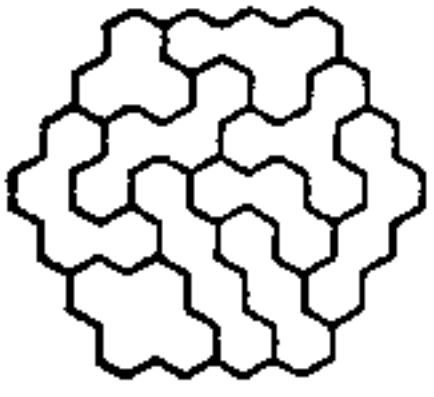

BASE PATTERN

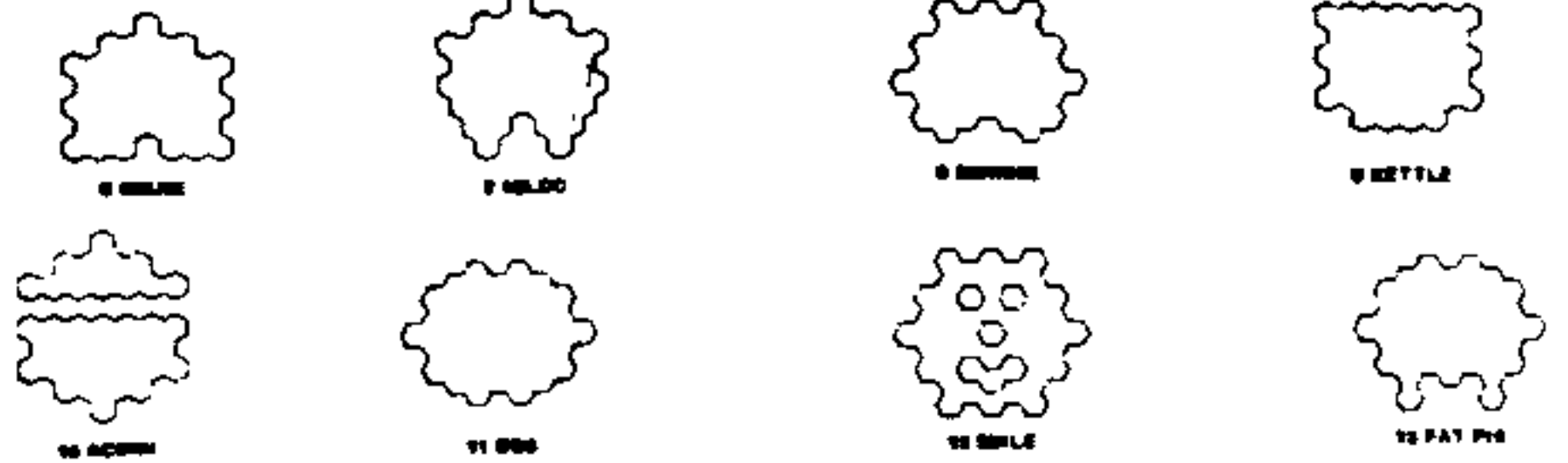

## PATTERNS WITHOUT THE BASE

**Puzzles 14-25** - Do not use the Base for the symmetrical patterns shown below and on next page.

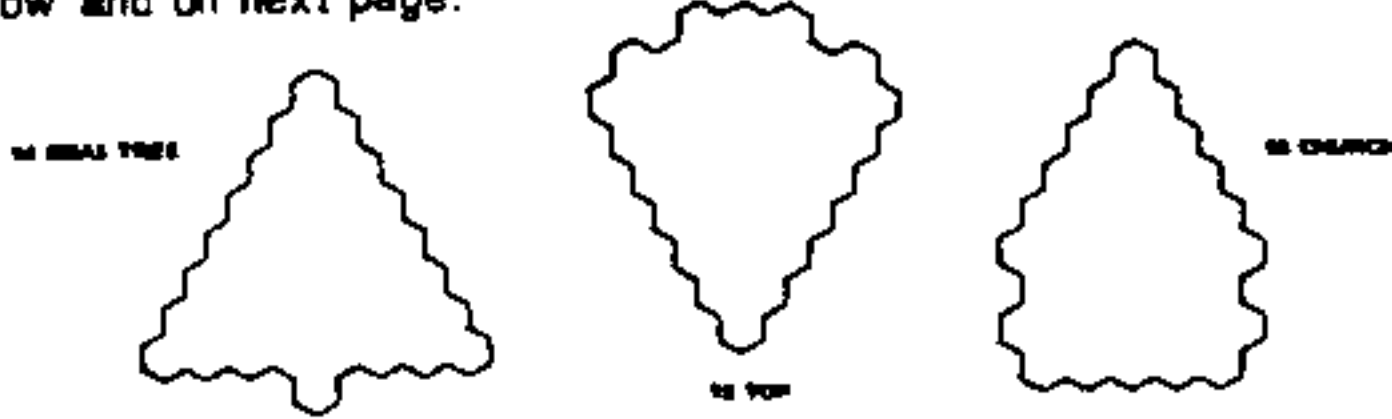

**DOUBLE PATTERNS** - One set of pieces makes both figures.

**Puzzles 26-28** - Solve these three Double Patterns -

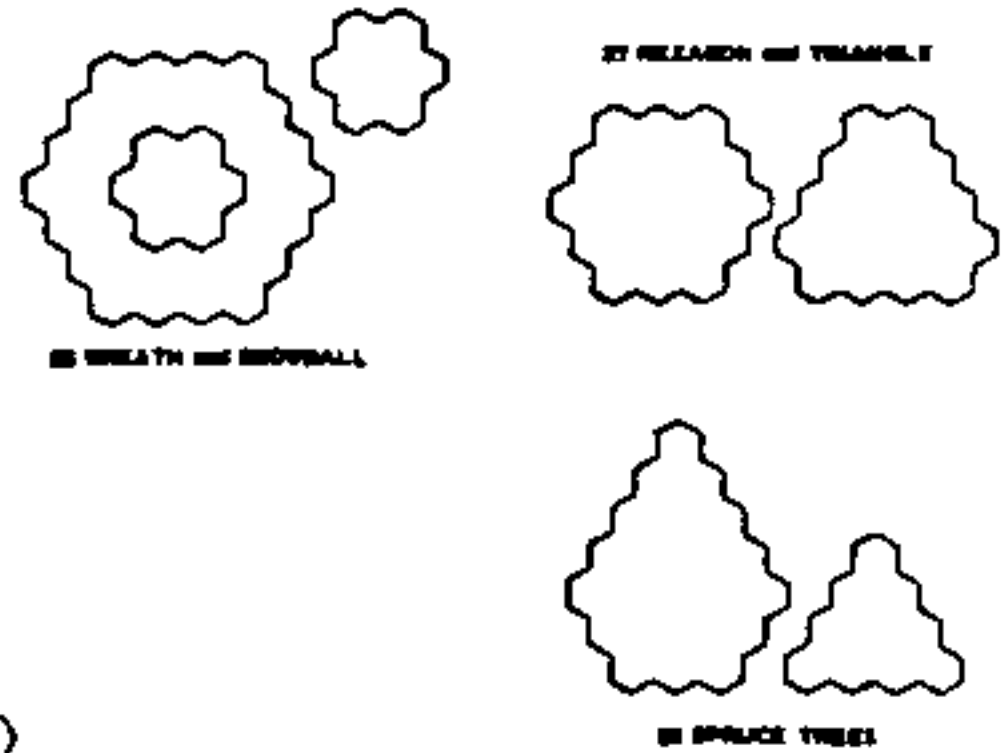

**TRIPLE PATTERNS** - One set of pieces makes all three figures.

**Puzzles 29-30** - Solve these Triple Patterns -

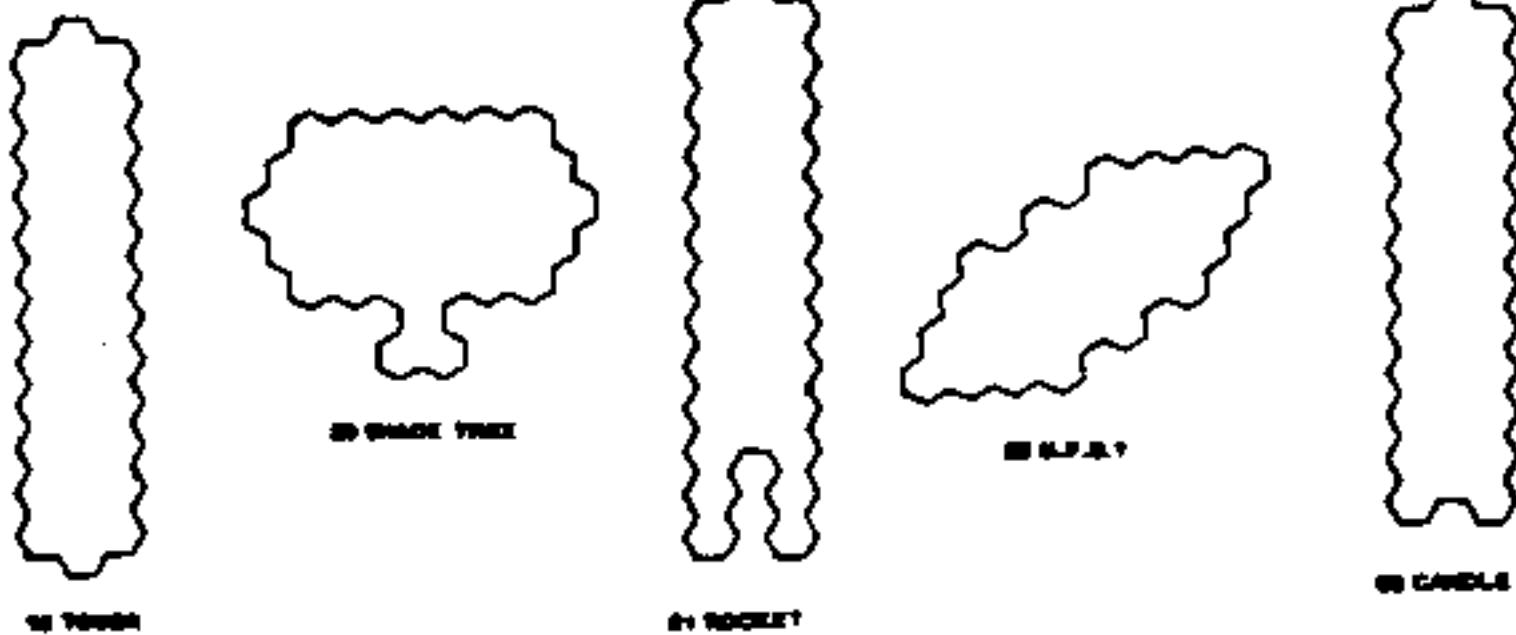
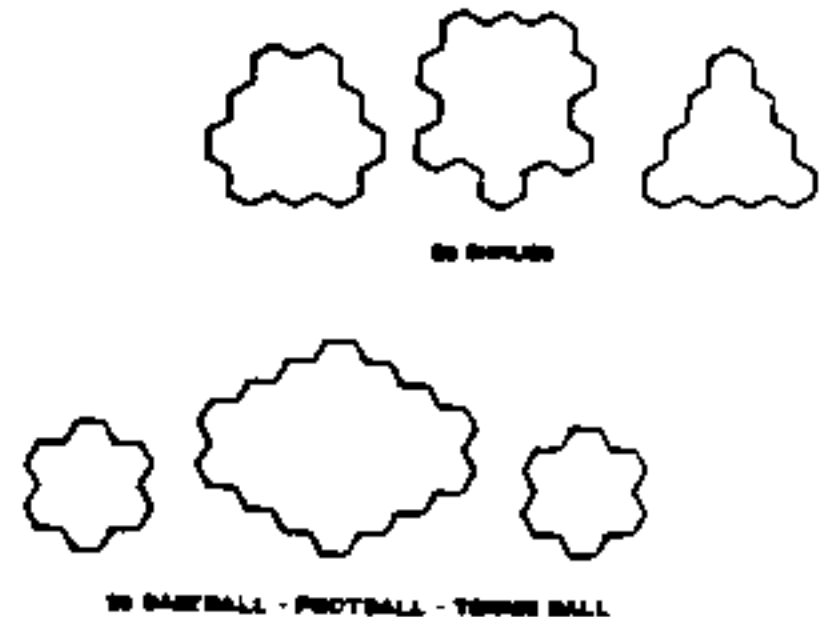

**PATTERNS WITH PIECES OMITTED - (Which ones?)**

**Puzzles 31-36** - Solve each of the problems shown below by omitting one or more pieces. Which piece do you omit to make OPEN TRIANGLE? Don't leap to a conclusion.

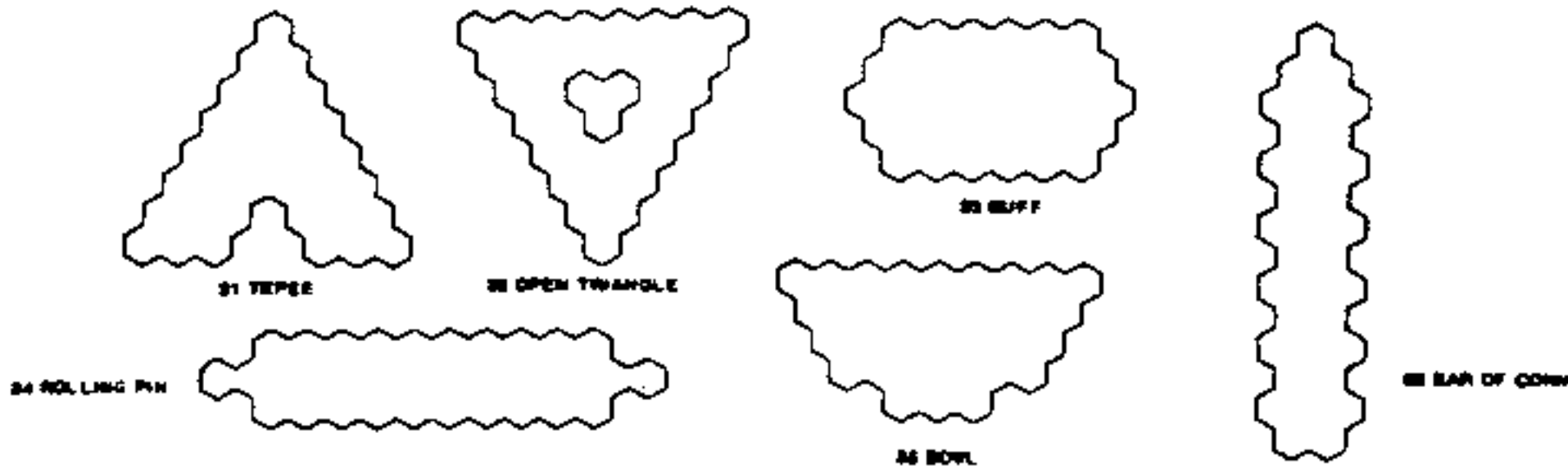

**IDENTICAL DOUBLE AND TRIPLE PATTERNS** - It is impossible to make identical Double or Triple Patterns using all the pieces, because the total number of hex units - 37 - is not divisible by 2 or 3. By omitting one or more pieces, however, some are possible

**Puzzles 37-38** - Solve these two Identical Triple Patterns -

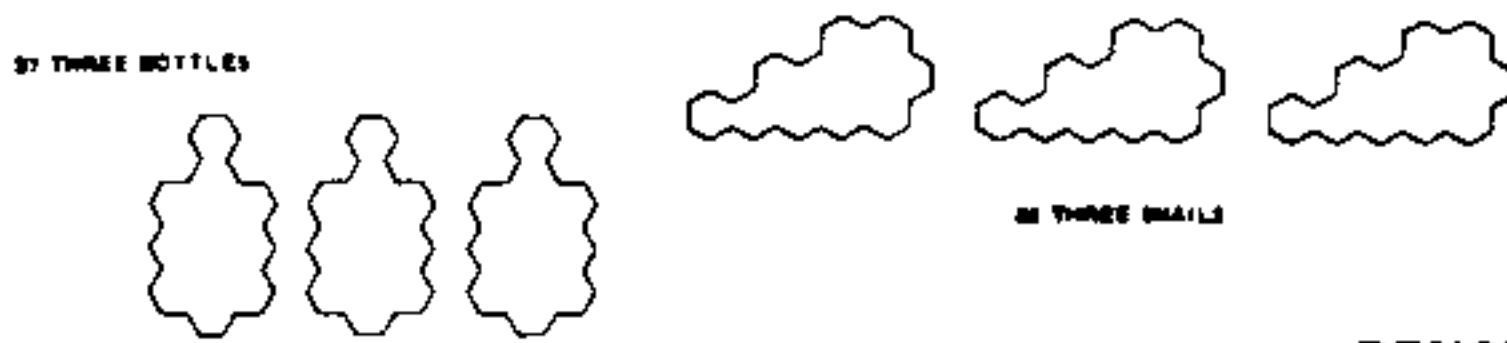

**DESIGNS**

Shown below are but a few of the myriad pictorial figures which can be made with this set. Detailed directions are not needed. Turn your imagination loose; see what new and original designs you can discover.

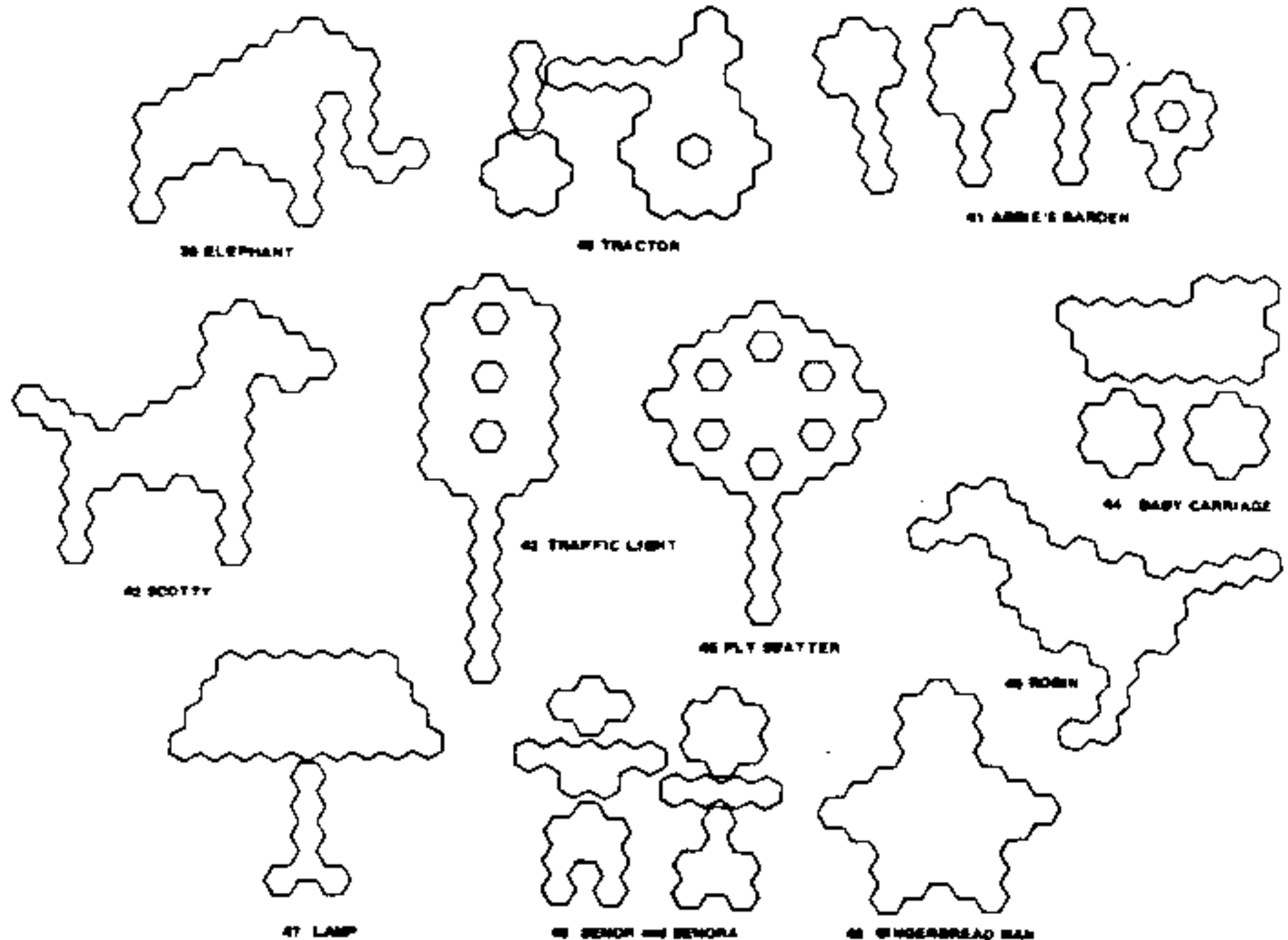

**Challenge:** The appealing double pattern, **DONUT and POPCORN BALL**, shown at right, has not been proven impossible, but has foiled all attempts at solution. Can it be done? (Probably not.)

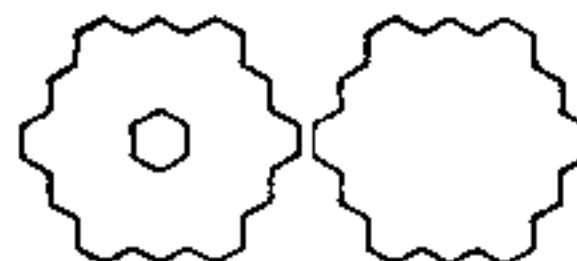

**DONUT and POPCORN BALL**

## Chapter 3 - Solid Block Puzzles

In this chapter, we will consider puzzles having pieces made up of cubic or rectangular blocks that, unlike those of the preceding chapter, are intended to be packed into solid three-dimensional assemblies. The first one of these to be described, Abbie's Puzzle, could go in either chapter, since an interesting variation of it would use square blocks and construct only flat assemblies. However, we made only the solid version with cubic blocks, probably the more interesting, and so it belongs in this chapter.

### Abbie's Puzzle

When we first went into the business of making wooden puzzles in 1970, our three girls were ages 10, 8, and 6. They quickly became adept with the puzzles and played an important role in this family enterprise, helping make them, demonstrating and selling them at craft fairs, and finding solutions. I encouraged them to design puzzles of their own. Out of this came Abbie's Puzzle. It was this puzzle she demonstrated when we did a segment for the children's television program called ZOOM! Our show was first aired on WGBH-TV on Dec. 9, 1973. The idea was for simple recreations that viewers could do themselves by sending for directions, so this is a suitable puzzle project for beginners. If you have no woodworking facilities whatsoever, you can probably buy wooden blocks in a hobby store. But check them for accuracy. Even simple puzzles such as this one are better if accurately made. Small errors can quickly accumulate when you start gluing blocks together, as you will soon discover!

Start with 24 cubic blocks, say one-inch size, and bevel the edges slightly. Then glue them together to form six puzzle pieces, as shown below. Now assemble the pieces into a 5 x 5 square with a hole in the center. There is only one way, but it is not very difficult. Make a shallow tray as previously explained to hold the square assembly slightly loosely, with an optional cover.

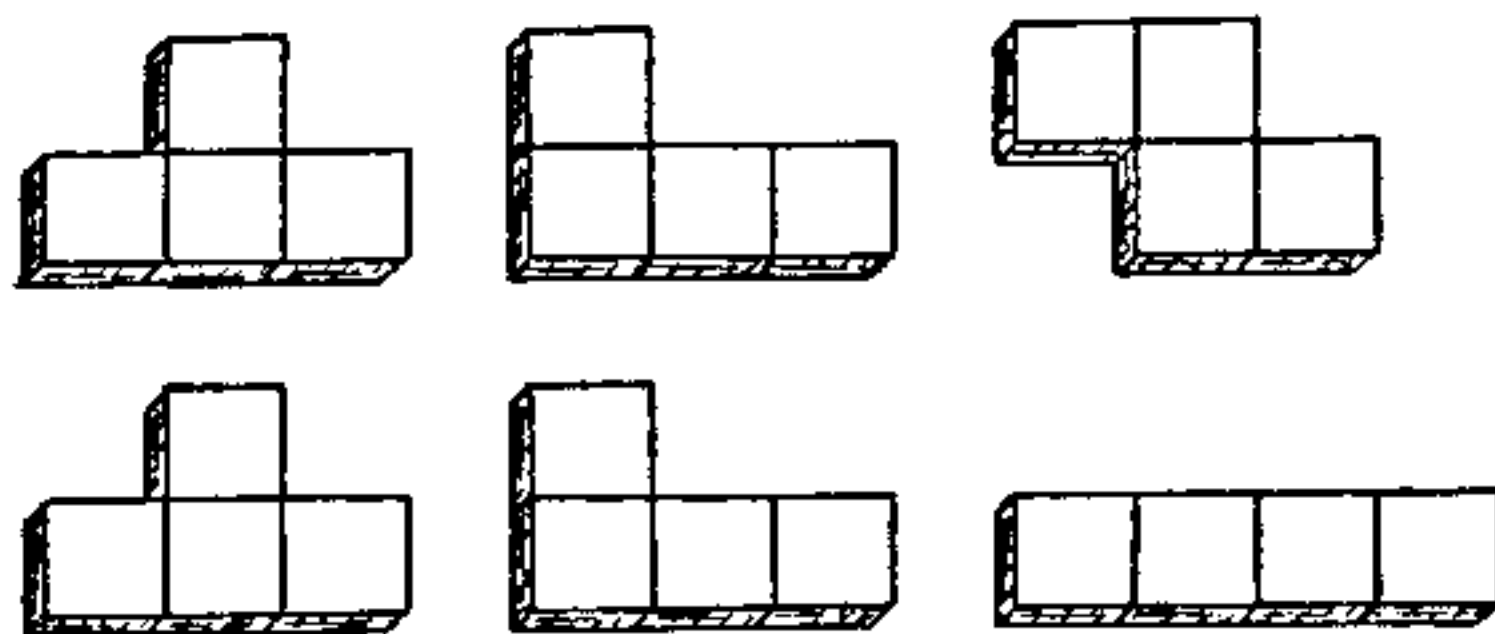

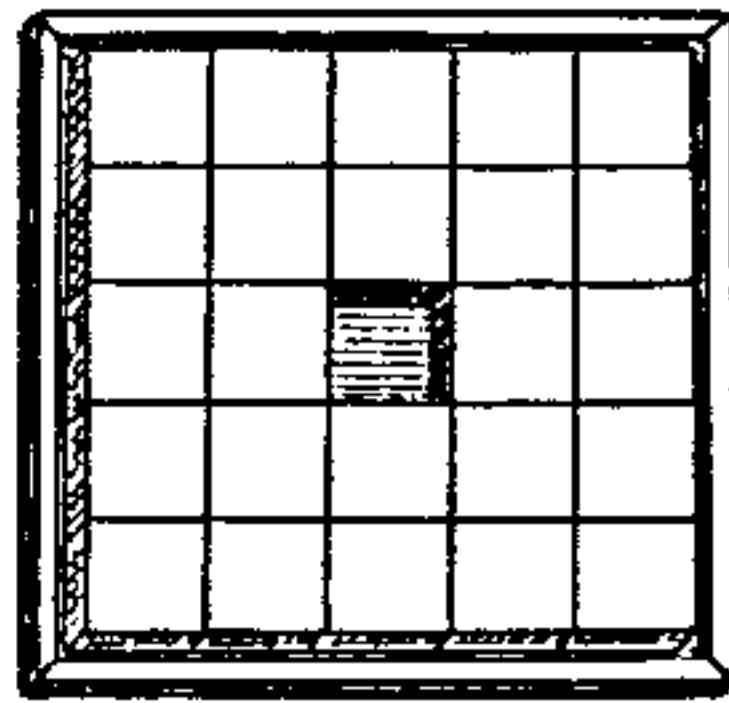

Other problems: Assemble the puzzle such that the empty space is located as in A, B, or C below. No solution has been found for D, and it is believed to be impossible.

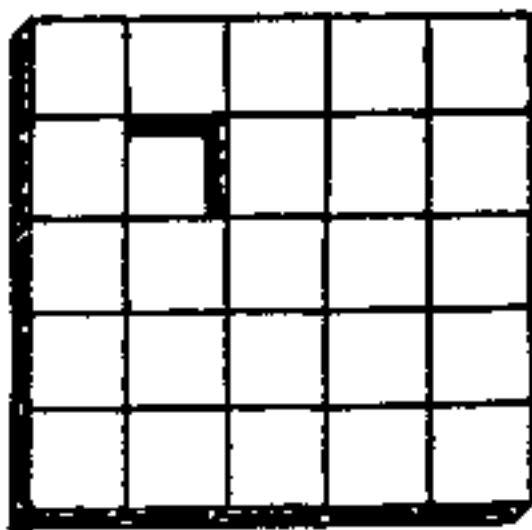

A

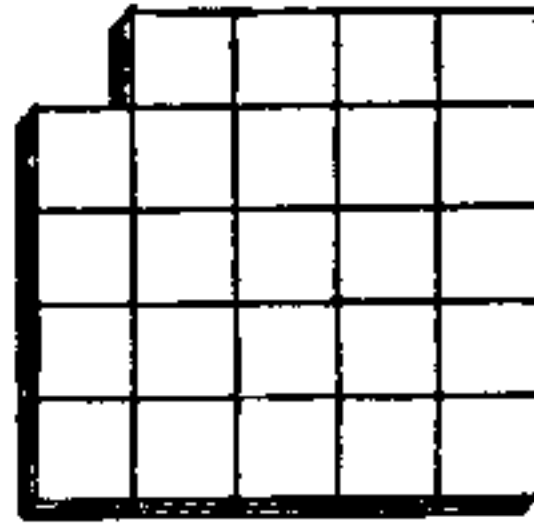

B

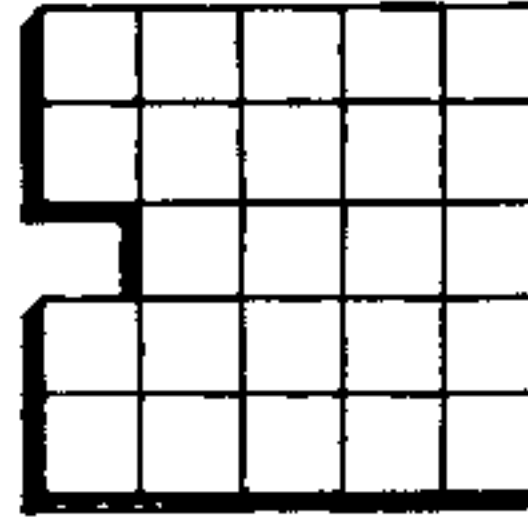

C

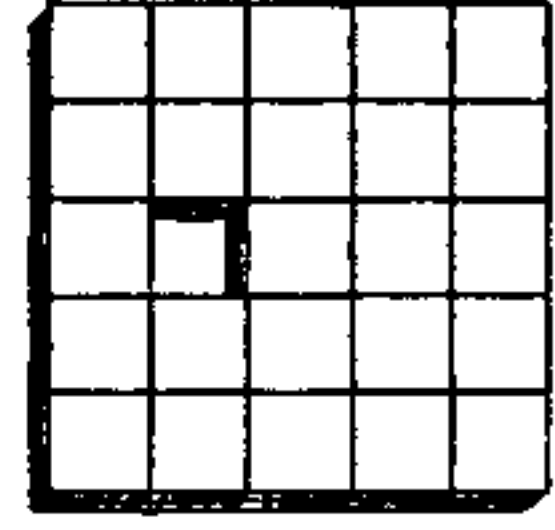

D - impossible?

Arrange the pieces to form a 4 x 6 rectangle. Four solutions are known.

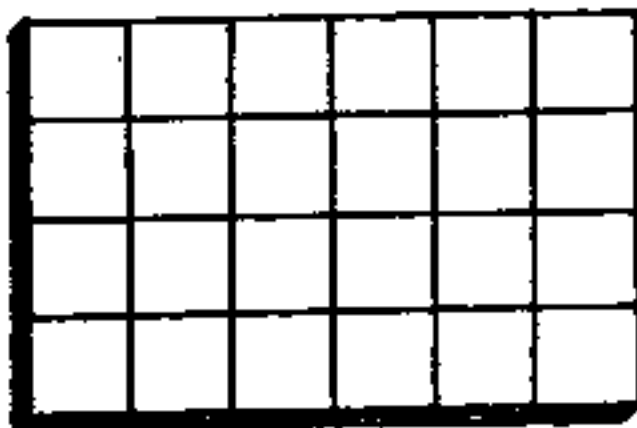

Arrange the pieces to form a 3x8 rectangle. Six solutions are known.



Construct a 2x3x4 solid assembly. There are at least eight ways, so this is not very difficult. For a variation of the tray above, make a box to hold this assembly.

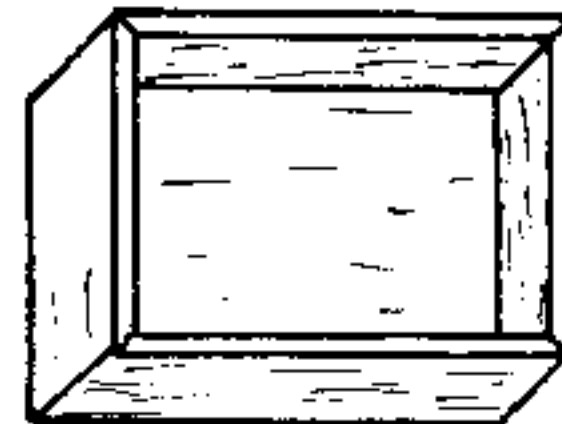
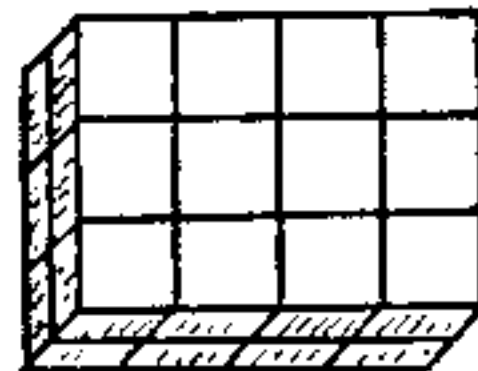

What other interesting constructions can you discover for this set of pieces? Sketch them and think up imaginative names for them.

## Pentominoes

In the same vein as Abbie's Puzzle, we should at least mention in passing the popular set of 12 puzzle pieces known as pentominoes, shown below.

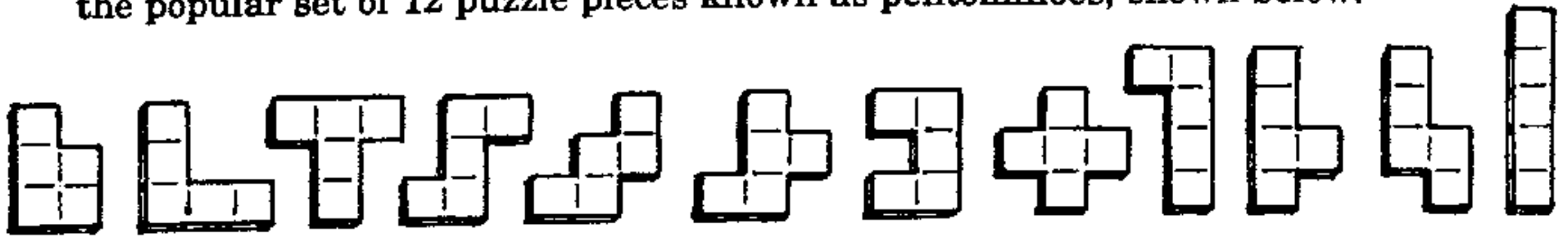

These were described by famous puzzle inventor Henry Dudeney in his 1907 book, *The Canterbury Puzzles*, and they were popularized in Solomon Golomb's book, *Polyominoes*, published in 1965. The flat version, made up of 60 square blocks joined together different ways, will construct a 3x20, 4x15, 5x12, or 6x10 rectangular assembly, as shown below. The solid version made up of 60 cubic blocks will also construct 2x3x10, 2x5x6, and 3x4x5 solid assemblies. There are multiple solutions, none of them easy. So much has already been published on pentominoes, we will not dwell on them here.

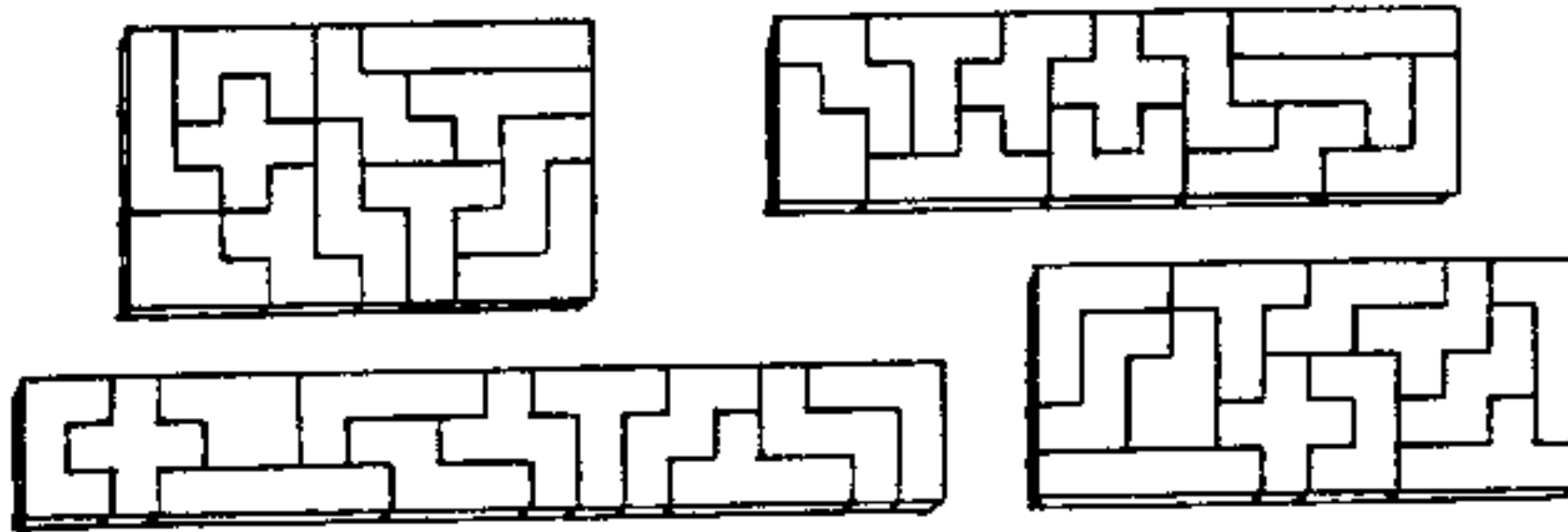

## Joined Pairs Puzzle

This one could be considered a variation of Abbie's puzzle (or vice versa). I stumbled upon the idea recently while working on my other book. The idea is so obvious that it has probably occurred to others independently. The puzzle is easy to make and also to solve.

Start with twelve 1x1x2 blocks and join them together all possible ways. You will end up with six puzzle pieces, as shown below.

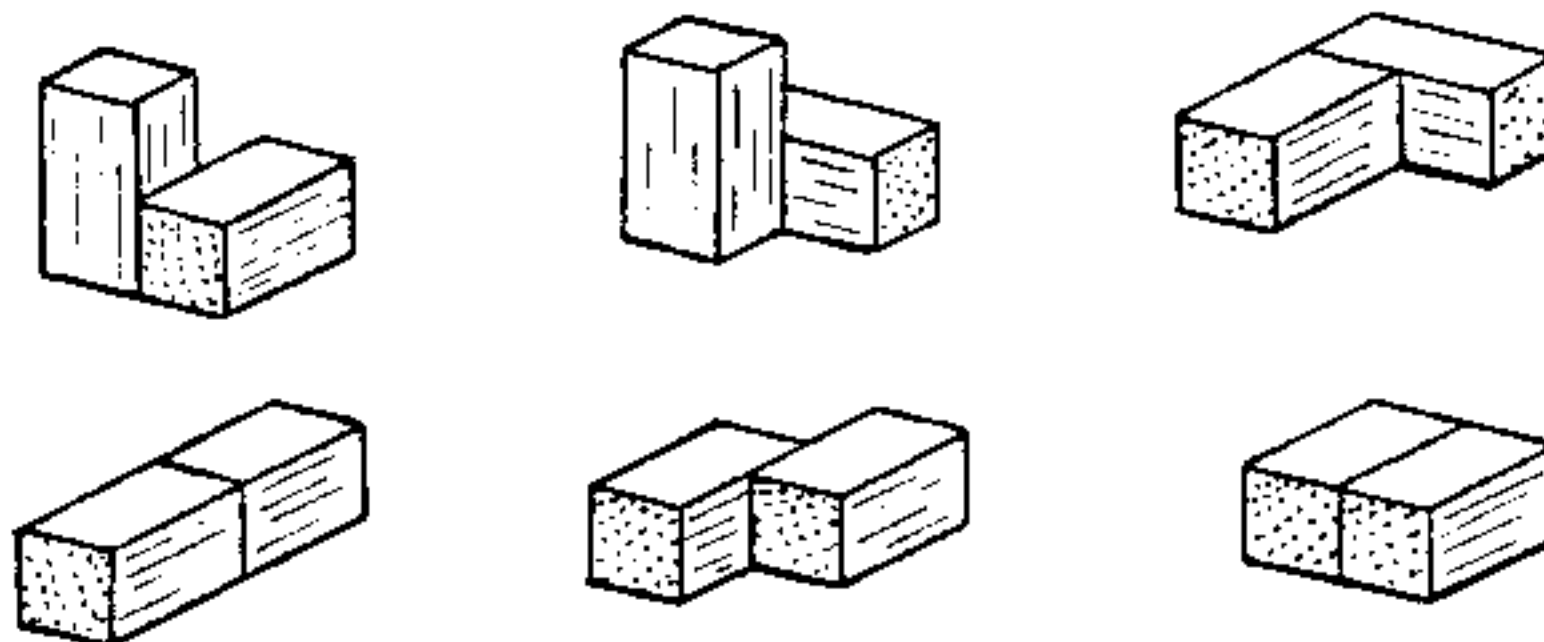



Now assemble them to construct a  $2 \times 3 \times 4$  solid. There are at least five solutions known, plus five more if you count reflections of those solutions, in other words as would be seen in a mirror image. One of these solutions, shown below, has an interesting pattern of symmetry in the arrangement of the blocks. See if you can discover it. What other interesting shapes can be constructed? Such pieces are fun to just play with. You can make a shallow box to hold the puzzle.

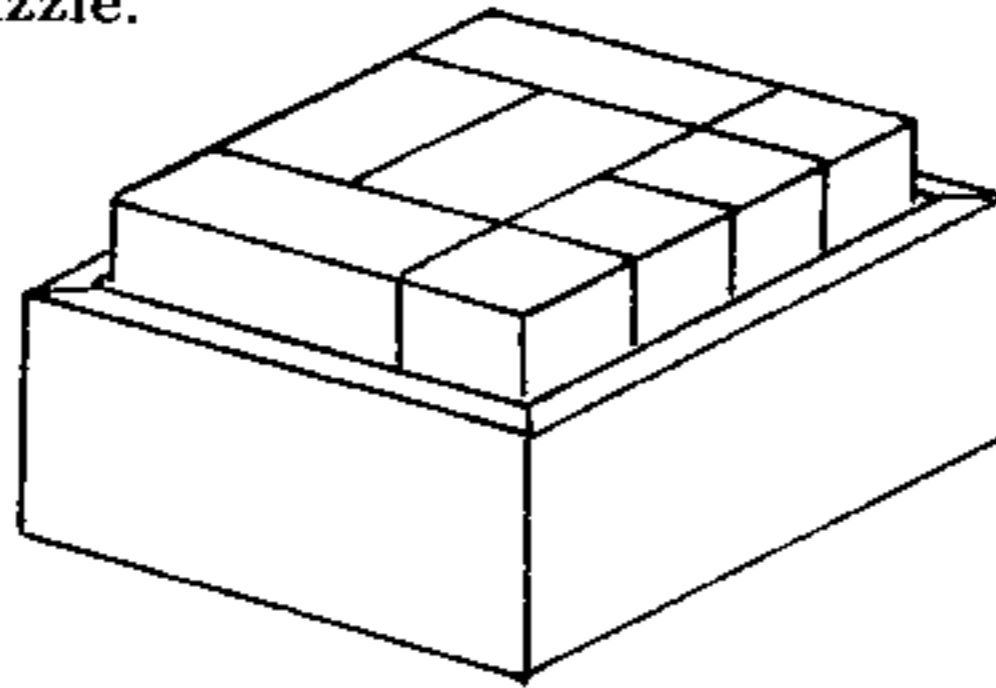

### Split Cube Puzzle

The original idea of this puzzle (not my own) was to cut cubes into two identical halves and then rejoin them by their half-faces or quarter-faces all possible ways. The result is the ten puzzle pieces shown below.

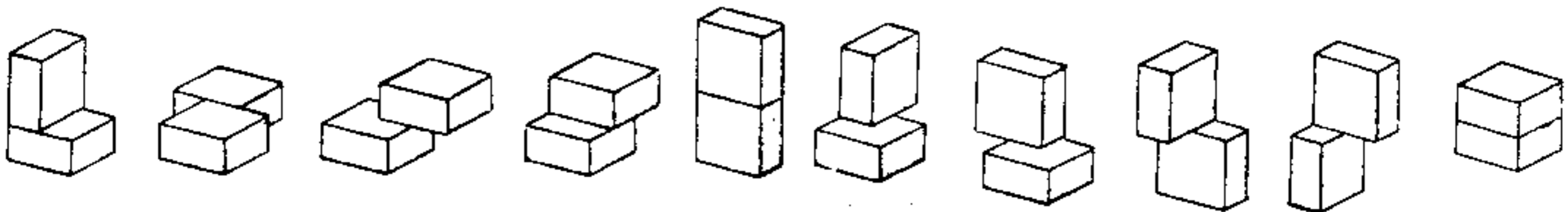

For purpose of discussion, let us describe the half-cubes as  $1 \times 2 \times 2$ . It is said that these ten puzzle pieces can be assembled into a  $4 \times 4 \times 5$  solid 25 different ways, although I must admit I have not yet discovered one way. A slight variation on this puzzle of my own design uses only eight pieces, two of which are alike, as shown below. When these are assembled into a  $4 \times 4 \times 4$  cubic solid, an interesting pattern of symmetry is revealed.

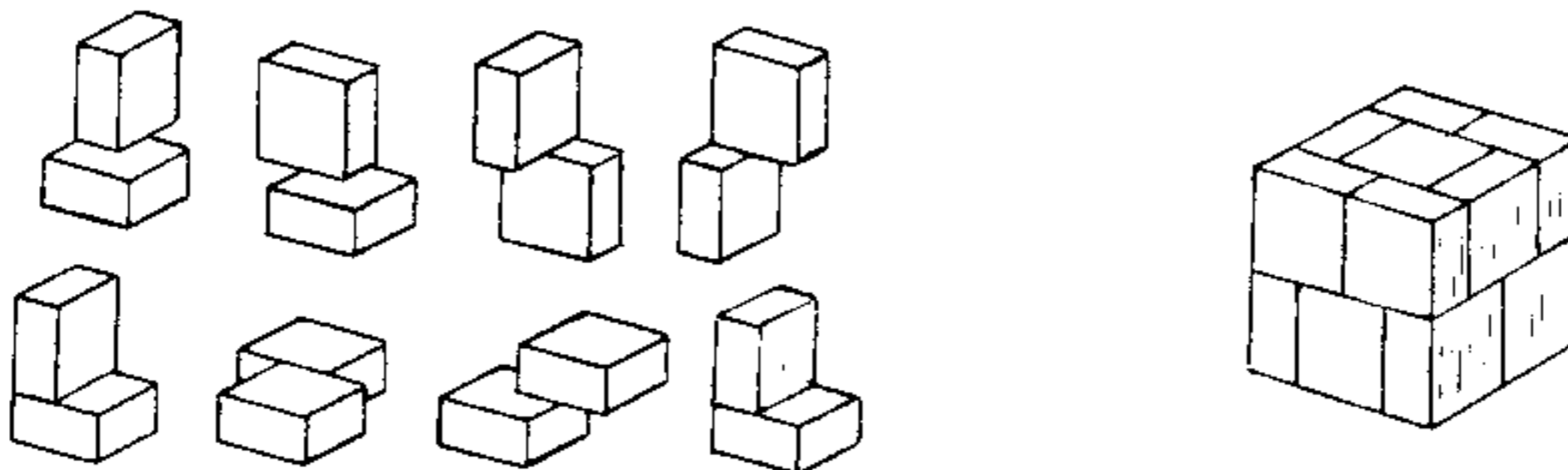

As a practical matter, you do not make these 1x2x2 blocks by sawing cubes in two, for to do so would be difficult, probably dangerous, and the kerf of the saw would destroy the accuracy. Nor do they need to be that large. Start with a planed board free of warp and of uniform thickness about 3/4-inch. Saw it into squares of a size exactly twice the thickness, so that two of them stacked together are an exact cube. Check this carefully. Break the sharp edges with fine sandpaper, glue them together as accurately as possible, and finish. A box and cover for this puzzle would follow the same plan as for trays and covers previously described.

### Half-Hour Puzzle

This puzzle has already been described in previous editions of *Puzzle Craft*, but since it has proven to be popular and easy to make, we will recycle it here, slightly condensed. Start with 27 cubic blocks, say one-inch cubes, and glue them together to make the six puzzle pieces shown below. They assemble one way only to form a solid 3x3x3 cube. The solution is not difficult - it just requires some patience.

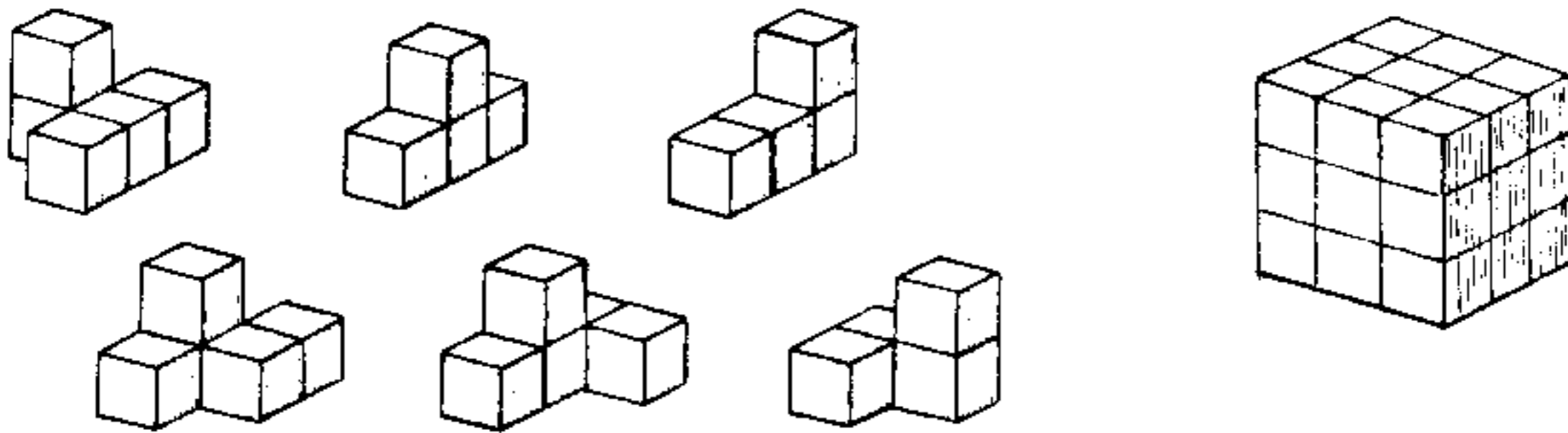

Here is but one more example of the virtually limitless recreational possibilities with even the simplest puzzles. When I designed this puzzle, it was intended to construct only the cubic solution. Below and on the next page are but a few of the hundreds of other constructions possible with this set of pieces, sent to me by Hans Havermann and David Barge.

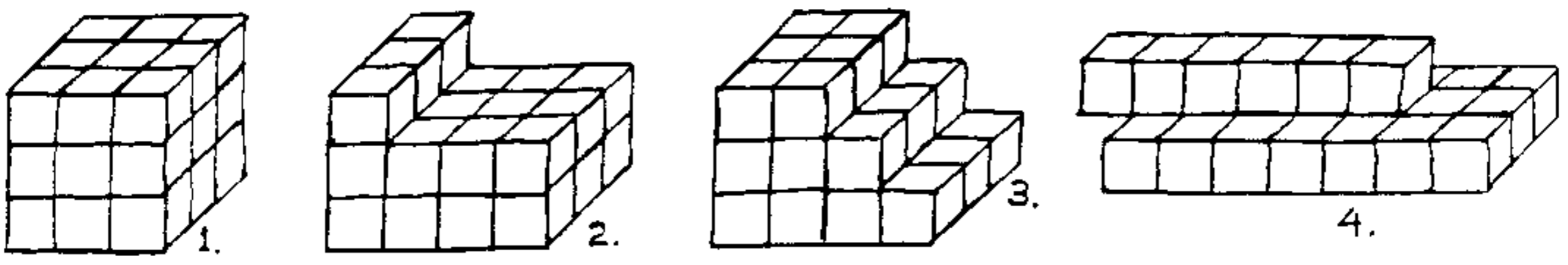

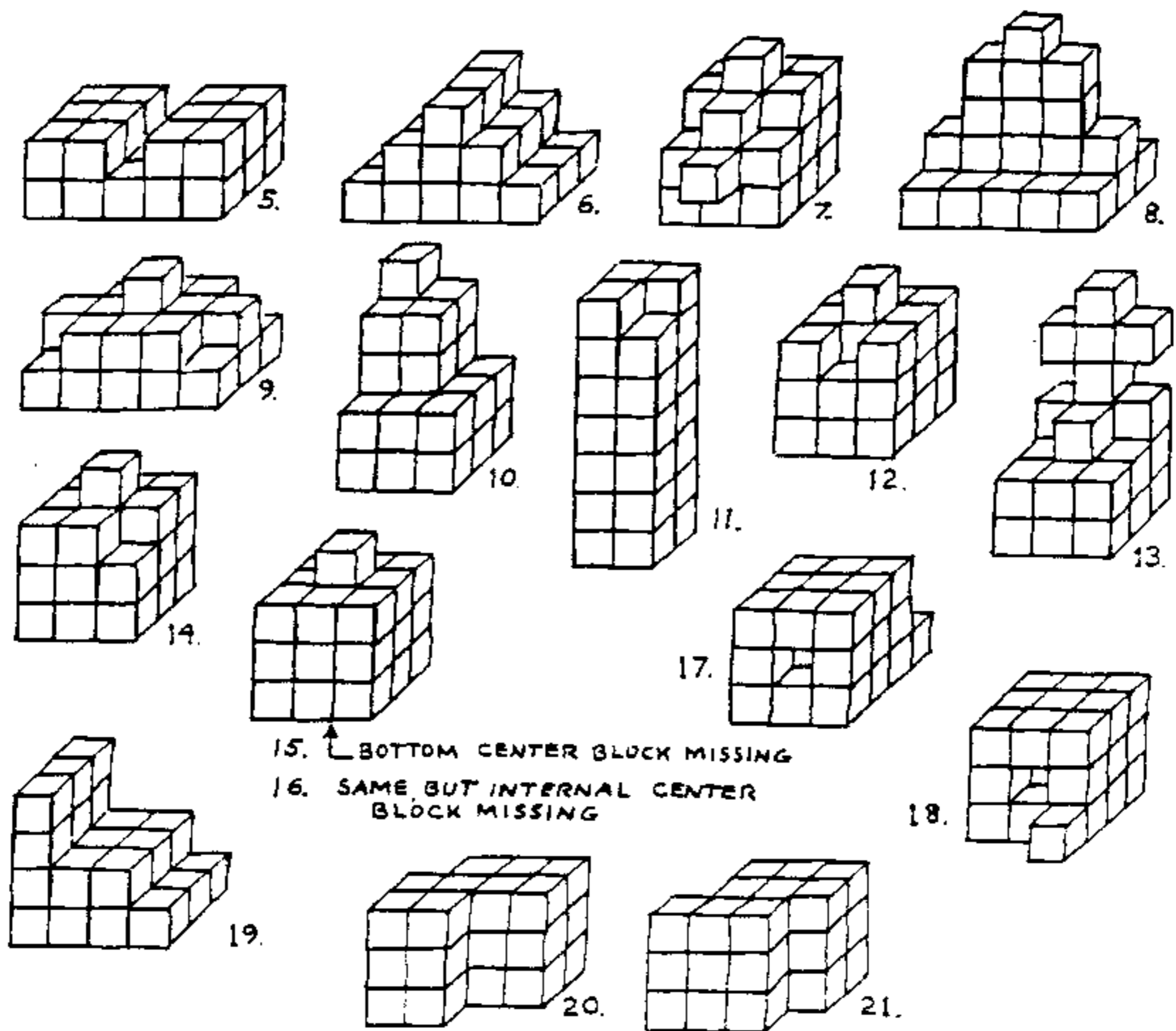

Back when I first started making and selling puzzles, and writing about them, I was inclined to omit solutions, assuming that most customers and readers would enjoy discovering them for themselves, that after all being the ultimate object of the puzzle. But then I started getting publicity through woodworking magazines, and I found that many woodworkers are interested in making puzzles, perhaps as gifts for family or friends, but *not* solving them. Consequently I received many requests for solutions, some complaints, and even a few returned books from disgruntled woodworkers! I have tried to correct that situation in this edition by including many more solutions, even for some of the easier puzzles. But there is a limit to this. This particular puzzle involves no difficulty whatsoever, just patience. For those who do not want to be bothered, why not just let someone else in the family or a friend solve it instead. Young children are especially good at these patience puzzles.

## Chapter 4 - Interlocking Block Puzzles

Up to this point in the book, none of the puzzles described would be considered interlocking. Accuracy of woodworking is desirable but not essential. Some could be made without power tools, and some even without any woodworking facilities. Nearly all of the puzzles to be described for the remainder of this book are interlocking. They require greater accuracy to be satisfactory or even assemblable at all. For this, you will probably need power tools - at least a table saw. You will also need a set of calipers for measuring.

### Five-Piece Solid Block Puzzle

This puzzle consists of 27 cubic blocks joined together to make five puzzle pieces that assemble with surprising difficulty to form a solid 3x3x3 cube. Although it may bear a superficial resemblance to the Half-Hour Puzzle and dozens of other puzzles of the 3x3x3 cubic block type, what makes it unique among all such puzzles known to me is that if accurately made it is interlocking. For those with a bent for tinkering, see if you can discover another interlocking combination with five dissimilar, non-symmetrical pieces made up of 27 cubic blocks. Good luck!

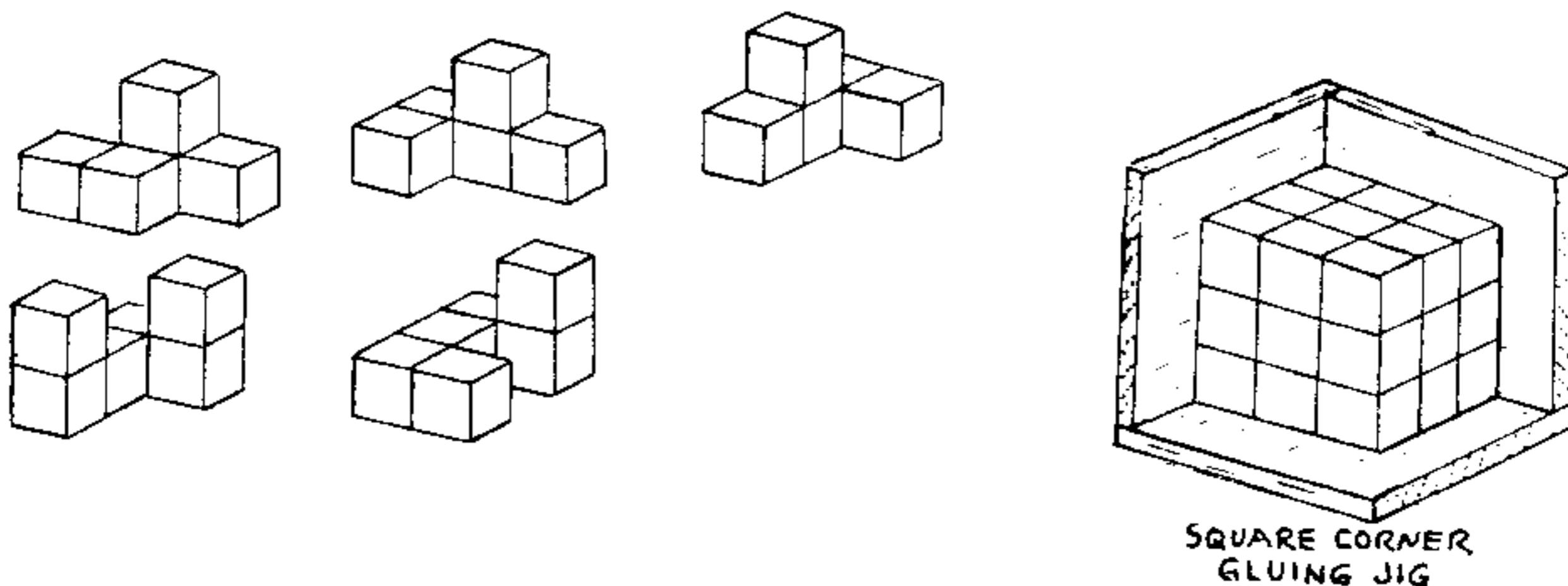

Check your 27 cubic blocks carefully for accuracy and uniformity. Then assemble them into a 3x3x3 cubic pile. You will need to devise some way to hold them accurately in this cubic pile. One way is to place them into a square corner of a box. Now start selectively gluing the blocks, placing them back into their assembled positions while the glue sets, and if necessary using bits of waxed paper to prevent accidental glue joints. This is the only practical way to achieve the necessary accuracy. You should also use a fairly stable wood, such as mahogany. If that is not available, here is one alternative: Use a type of wood in which the grain is not too

obvious, and align all the blocks with the grain running in the same direction. When this is done, the adverse effects of expansion and contraction with changes in humidity are minimized. Of course, the alignment of the grain may tend to give away the solution, but few persons will think of it, and with the right choice of wood, it will not be obvious. See illustration below.

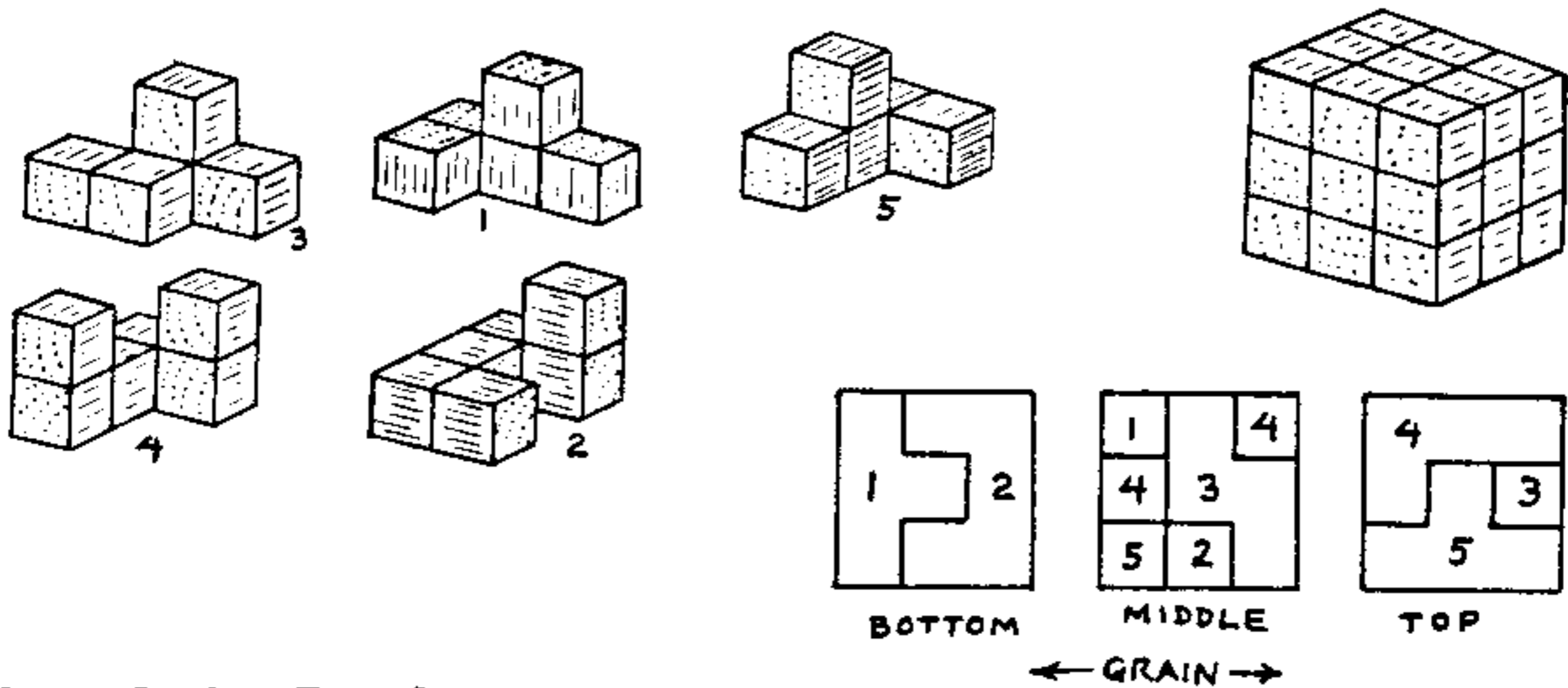

### Convolution Puzzle

I designed this puzzle in 1980 and produced it for a few years thereafter. Because of the large numbers of close fitting parts and glue joints, not to mention confusing assembly, it is a project for the advanced puzzle maker. Start with 24 blocks 1x1x2 and 16 cubic blocks 1x1x1. Check them for accuracy and stack them in a cubic pile as with the preceding puzzle. Note the symmetrical arrangement of the rectangular blocks. All six faces of the cubic pile look alike. Eight cubic blocks go into the corners, and the other eight are in the center. The diagram shows the make-up of the pieces. These are cross-sectional diagrams of the four layers as seen from above. Familiarize yourself with this sort of representation, as it is very useful in three-dimensional puzzle work and used often. Start gluing the blocks together, again placing them back tightly in position while the glue sets. You can glue them in any order you wish, but note that when finished, the puzzle can be disassembled in one order only, as indicated by the numbering. Piece 7 comes out first. Likewise when assembling, pieces 1 and 2 must be assembled first. There is one tricky step with piece 5, as it must be rotated to remove or assemble. Some edges may have to be sanded slightly to permit this. When finished, the assembled puzzle may be sanded on all six outside faces on a belt sander, lacquered, and polished to bring out the beautiful symmetry in the wood grain patterns.

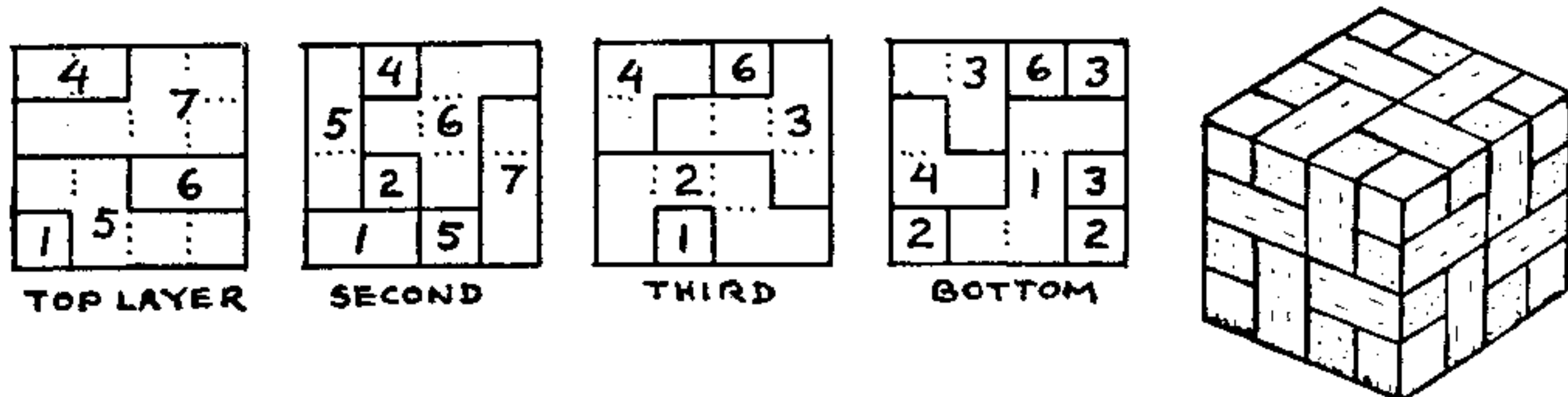

### Three Piece Block Puzzle

This amazing puzzle has been described in previous editions, but this is the first time I have published the solution and directions for making it. It was designed in 1980 for a corporate client as a simple advertising giveaway. Later I made and sold it myself. Much to my surprise, it soon became one of my most popular and sought after puzzles, and also one of the most perplexing. It has baffled experts.

It is not too hard to make, but it may take some practice to get the accuracy necessary for a really good fit. Start with 20 one-inch cubic blocks of a stable wood that glues well, such as mahogany or cherry. Check them carefully for uniformity. Sand all edges, or still better bevel them carefully with a file. Ten of these blocks are for the puzzle, and the other ten are for the gluing jig. Making an accurate jig is the trickiest part. The ten blocks are glued together exactly by their quarter-faces, as shown below. This is most easily done using some accurate 1/2-inch shim blocks. Anyone with machine shop experience should be able to figure out how to do this. Have the grain of all blocks run in the same direction. Lacquer and liberally wax the finished jig to prevent accidental glue joints.

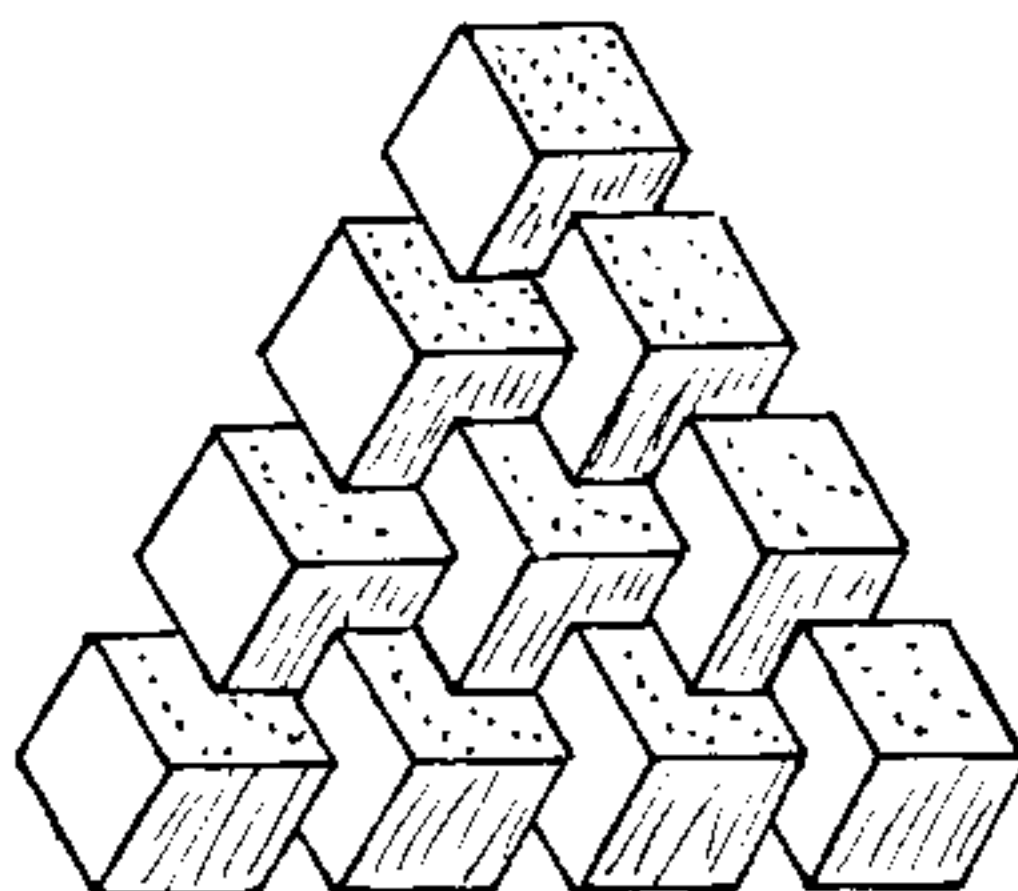

Place blocks A, B, and C in the jig and join them by their quarter-faces, again with the grain of all blocks running in the same direction. Place blocks D and E and join them likewise by their quarter-faces. Place block H to complete the bottom layer. Place block I and join it to block H by their

half-faces. Place block J and join it to block I by quarter-faces. Place block F and join it to block D by half-faces. Place block G on top and join it to block F by half-faces to complete the pyramid. It should now come apart with a little coaxing if you have not accidentally glued pieces together. Note that piece A-B-C cannot go in last or come out first. If you have followed my suggestion of having the grain of all blocks run in the same direction, the puzzle should be little effected by humidity. Knowing that, the grain direction may be a hint at the solution, but with this puzzle, every little bit of help will be most welcome!

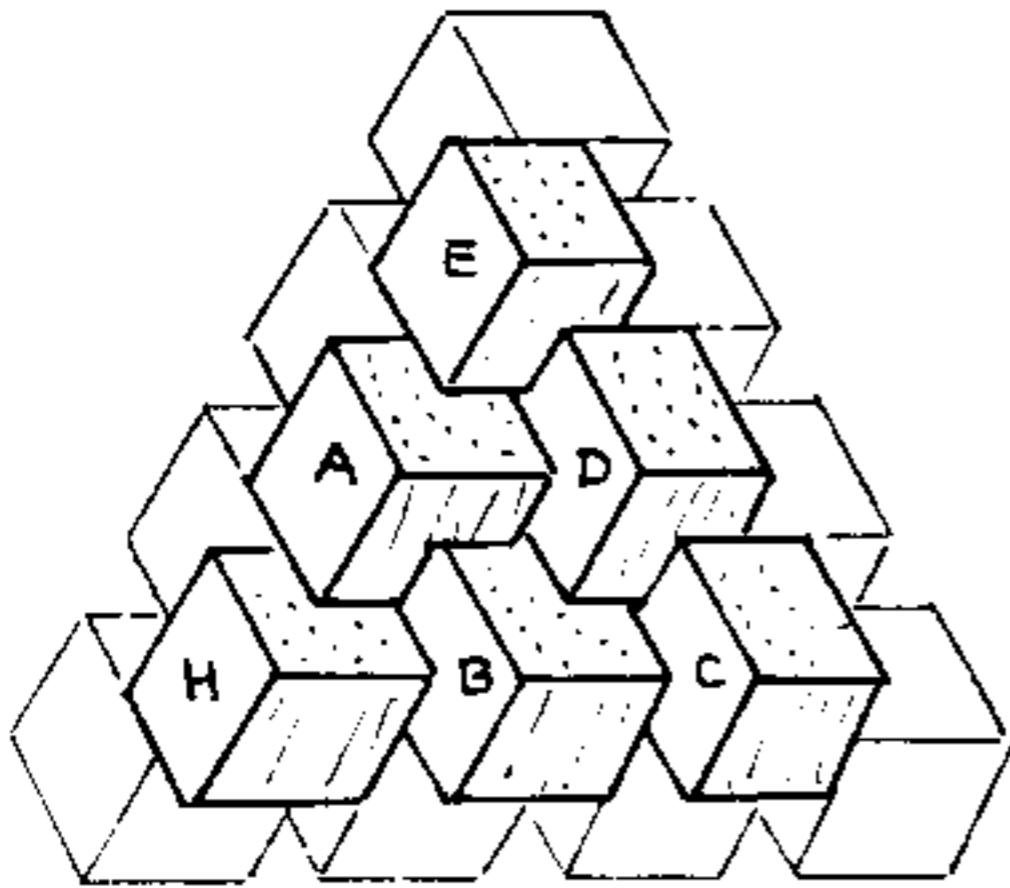

1.

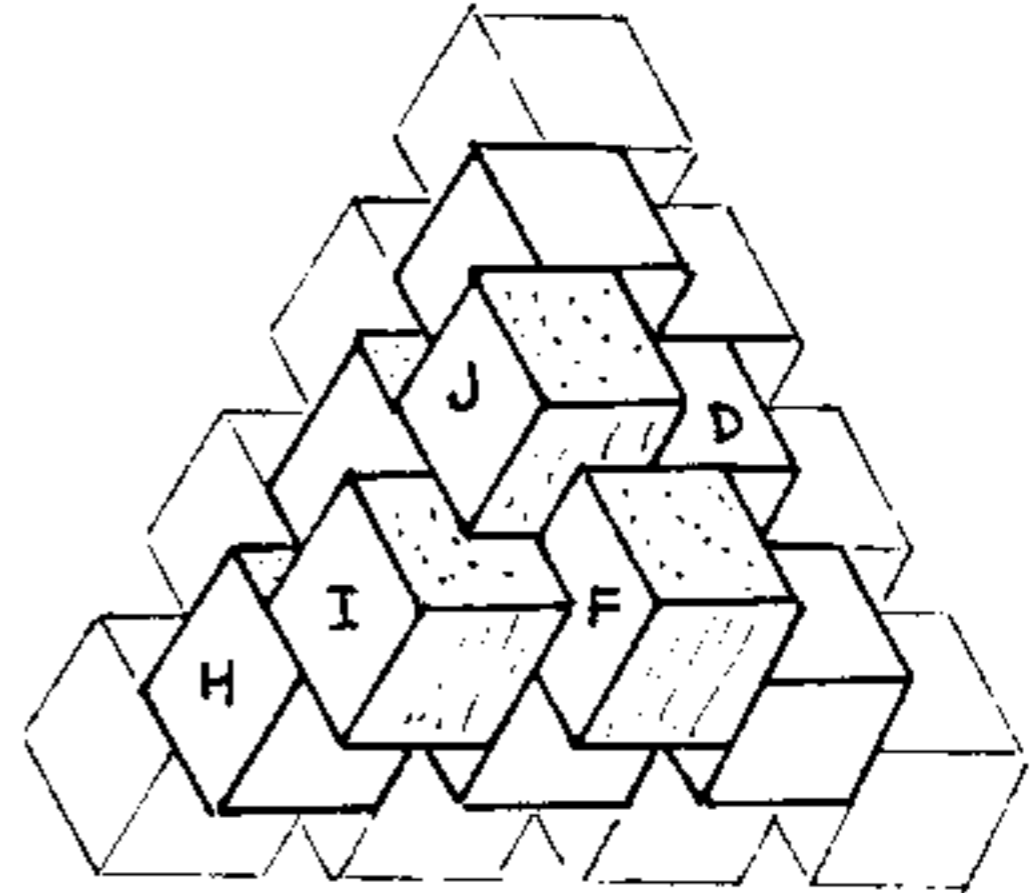

2.

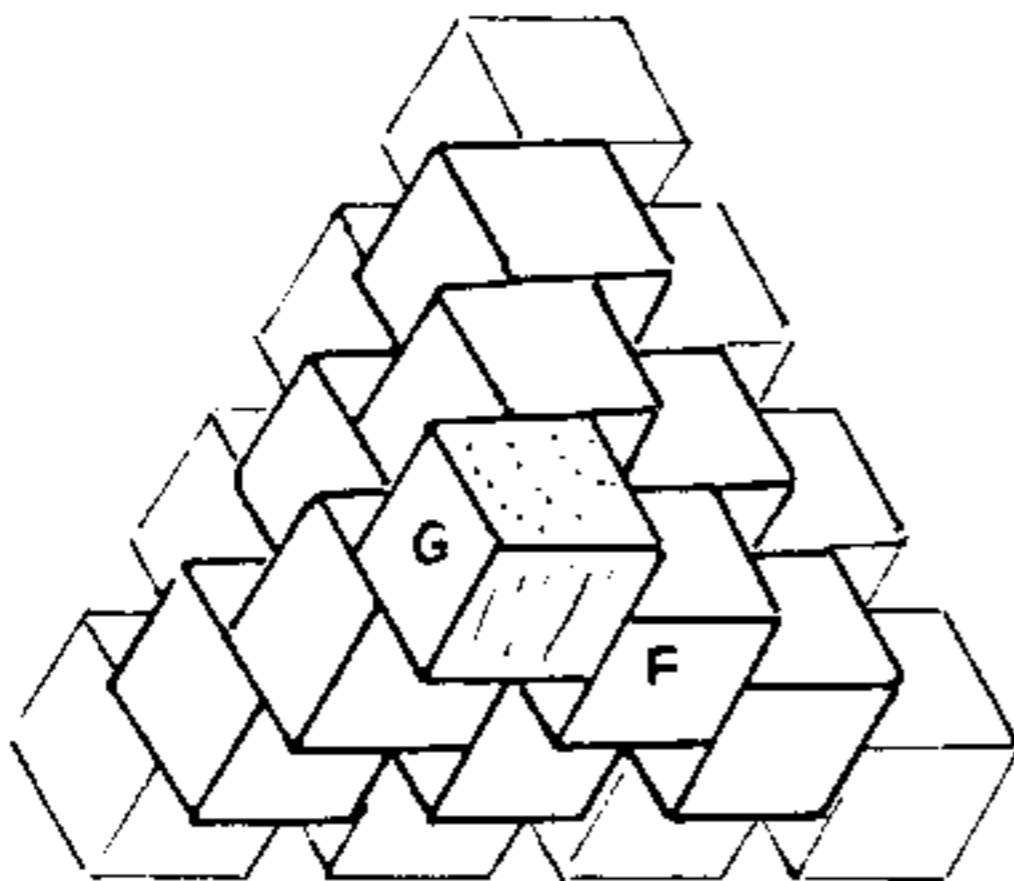

3.

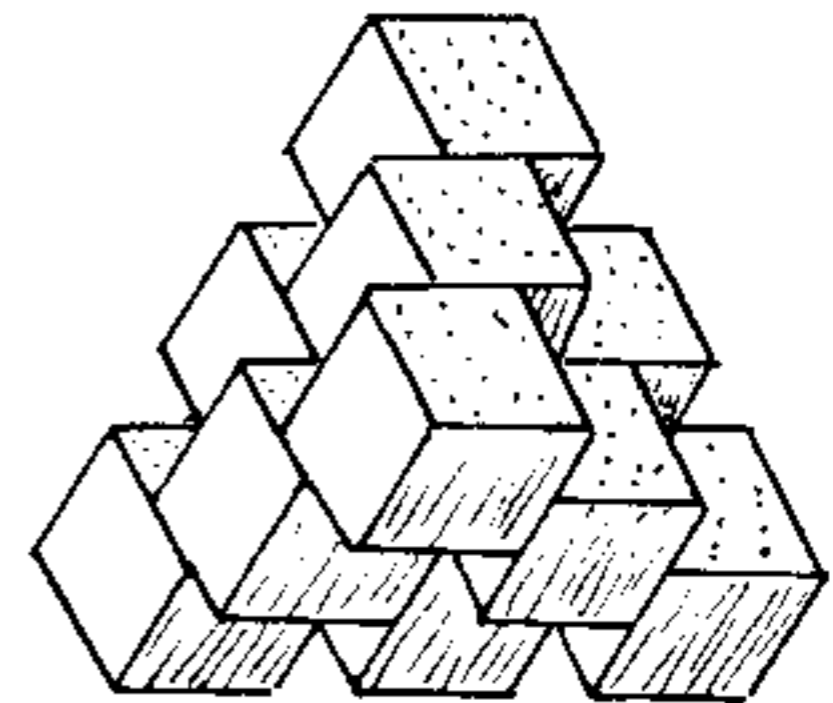

4.

## Chapter 5 - Burr Puzzles

Over the years, the standard six-piece burr has maintained its popularity as probably the best known and beloved of all interlocking wooden puzzles. It is one of my favorites too. From among the hundreds of different versions invented, patented, manufactured, or published during the past century, I have selected the two following for inclusion in this edition. Both of these were discovered by Bill Cutler using a computer. The first one, Burr No. 305, happens to be my favorite. At one time I produced them in quantity.

### Burr No. 305

This puzzle is easy to make, as all of the notches can be made directly with a saw or dado, without the need for chiseling out blind corners or gluing in blocks. It has an interesting and unusual solution, although not terribly difficult.

Start with a length of accurate, uniform hardwood stock one-inch square, and saw it into six pieces three inches long (or scale proportionally to smaller dimensions if you wish). The drawings below are half scale if using one-inch stock. All notches are nominally one-half inch deep and one-half inch wide or exact multiples of one-half inch. In order for the pieces to fit together, the one-inch square dimension should be taken as *not greater than*, and the notch dimensions *not less than*.

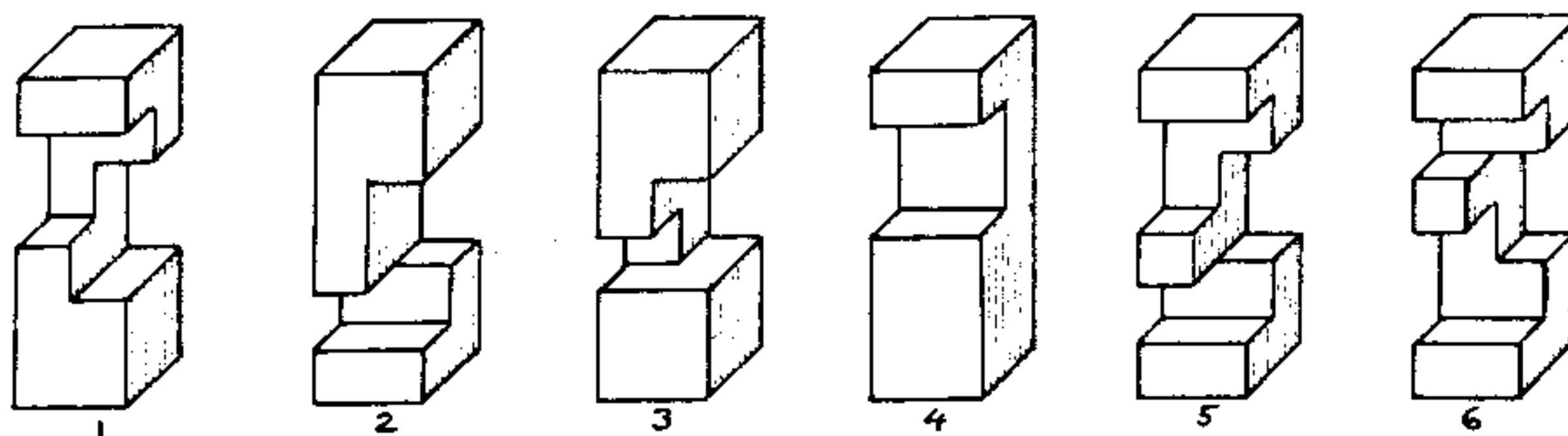

Without spoiling all the fun by giving the complete solution to this interesting but not too difficult puzzle, here are some hints: There is no key piece. In fact, the puzzle slides together surprisingly in two halves of three pieces each. Pieces 1-2-3 mate with pieces 4-5-6.

### Cutler's L5 Notchable Burr

This version is likewise notchable, meaning that there are no blind corners to carve out. Unlike Burr 305, it is not solid, but rather has voids



inside when assembled. This allows fiendish complications to be incorporated into the design. Disassembly of this burr requires five shifts of pieces before the first piece can be released. Consequently, it is very difficult to assemble. Cutler's specializes in very difficult burrs, and he is no doubt the world's foremost expert on them. His policy is in general to not publish explicit assembly directions for them. Why spoil all the fun? I tend to agree with him on that. Therefore, in an exception to the general rule in this edition, no assembly directions are given for this quite difficult puzzle. If you don't like difficult puzzles, better skip this one!

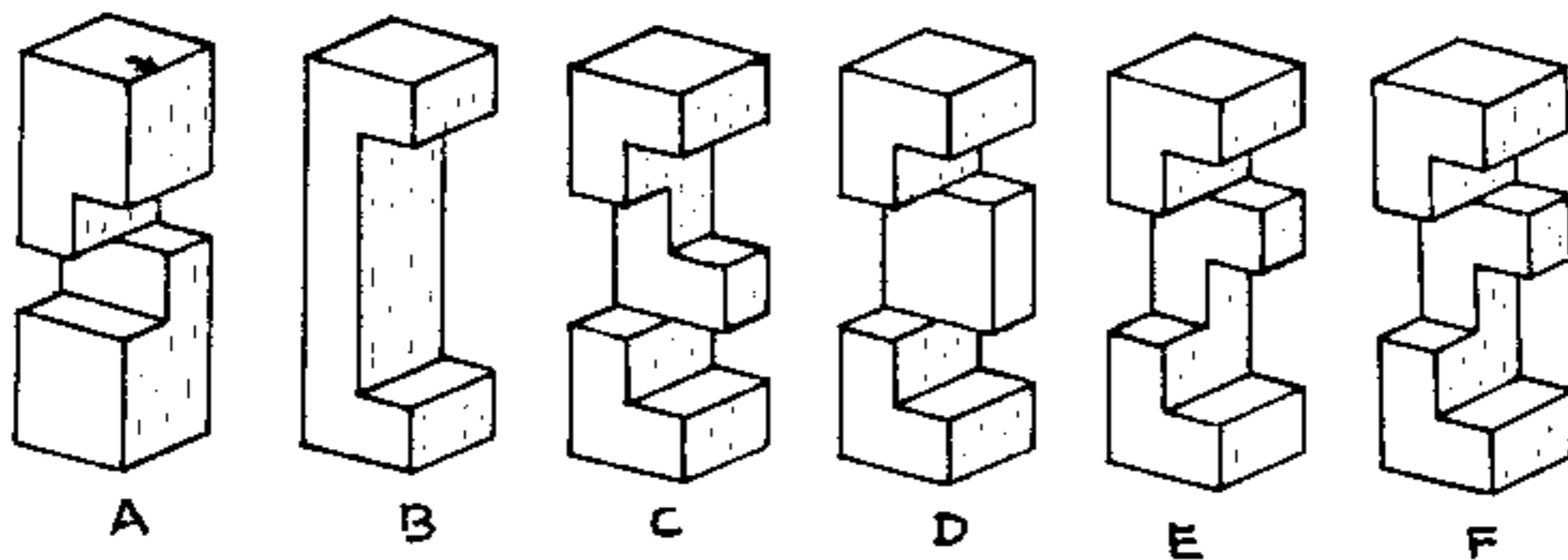

However - here are some big hints: The positions of the pieces are shown in the drawing below. If you want to cheat, here is the way to do it on puzzles like these. Assemble the puzzle with piece B left out. This may take a little tinkering but is not very difficult. Make piece B in two parts, as shown, and glue it together in place. Now play with the puzzle until you discover the five moves that release the first piece. It is usually much easier to solve burr puzzles in reverse this way, disassembling rather than assembling.

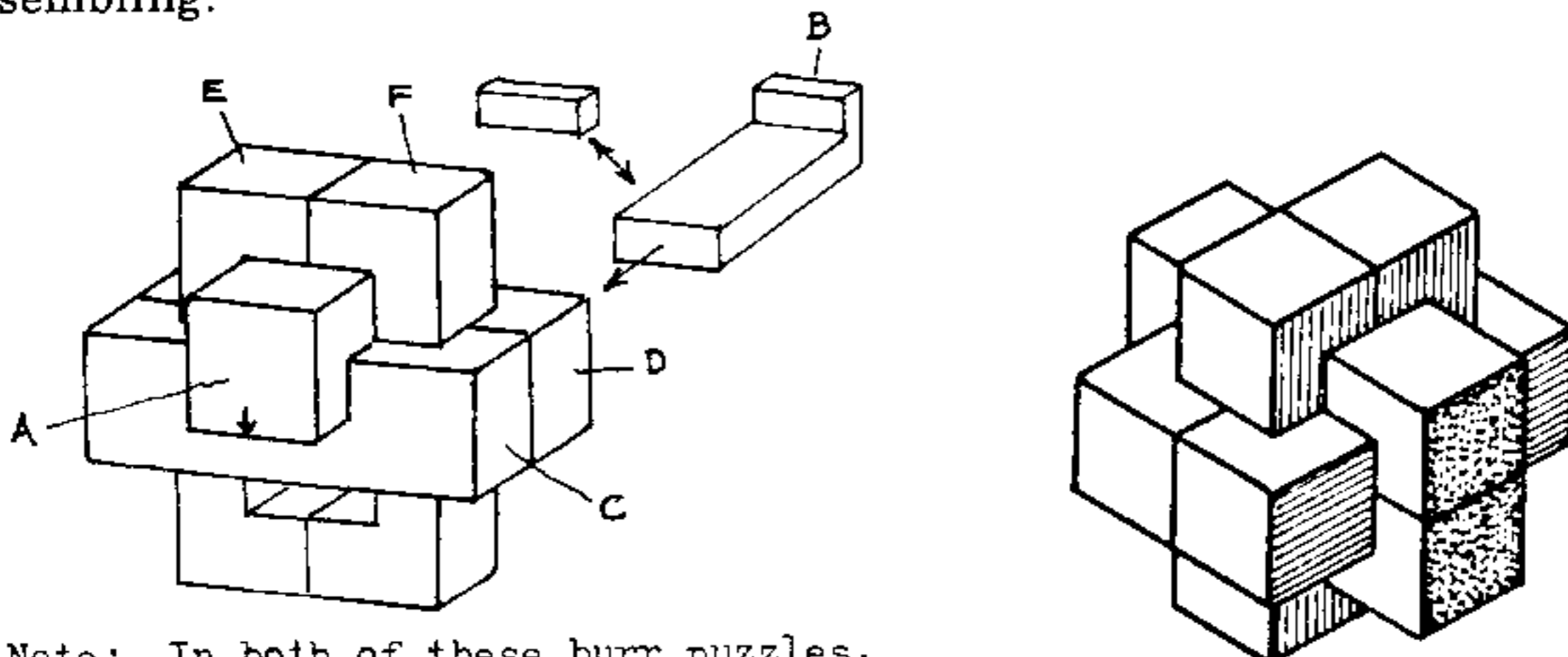

Note: In both of these burr puzzles, and in all others of this sort, if using one-inch square stock, all notches and other dimensions are in exact increments of one-half inch.

SIX-PIECE BURR

## Chapter 6 - Burrs with Pins and Holes

The burr puzzles in this chapter use pins and holes rather than notches to hold themselves together. They are fairly easy to make, requiring in addition to the usual woodworking tools a drill press, drill bits, and some dowel stock.

### Frantix Puzzle

This puzzle consists of 12 nearly identical pieces as shown below. The pieces can be shaped on a table saw using a dado blade. In order to avoid the hazards and difficulty of working near the blade with small blocks, the one-inch-wide notches can be made in a long continuous strip and the individual pieces then cross-cut out. Each piece has two holes, one of which is a close fit for the dowel and the other with about 1/32-inch clearance. Therein is a slight problem. You should use a spur bit for accuracy and neatness of hole. If you can find any at all, you are not likely to find them in 1/32-inch increments. You can grind down a standard drill bit into a spur bit if you are so inclined. Or you can make both holes oversized and hold the dowel in the hole using a brad. Use ordinary 3/8-inch birch dowels available in any hardware store. They are not always the size they are supposed to be. You can reduce them in size by sanding in a lathe to accommodate your spur bit size.

Six right-handed and six left-handed pieces are required. Assembly of the puzzle is tricky but not difficult. There is no key piece. The final step is the sliding together of two interlocked halves.

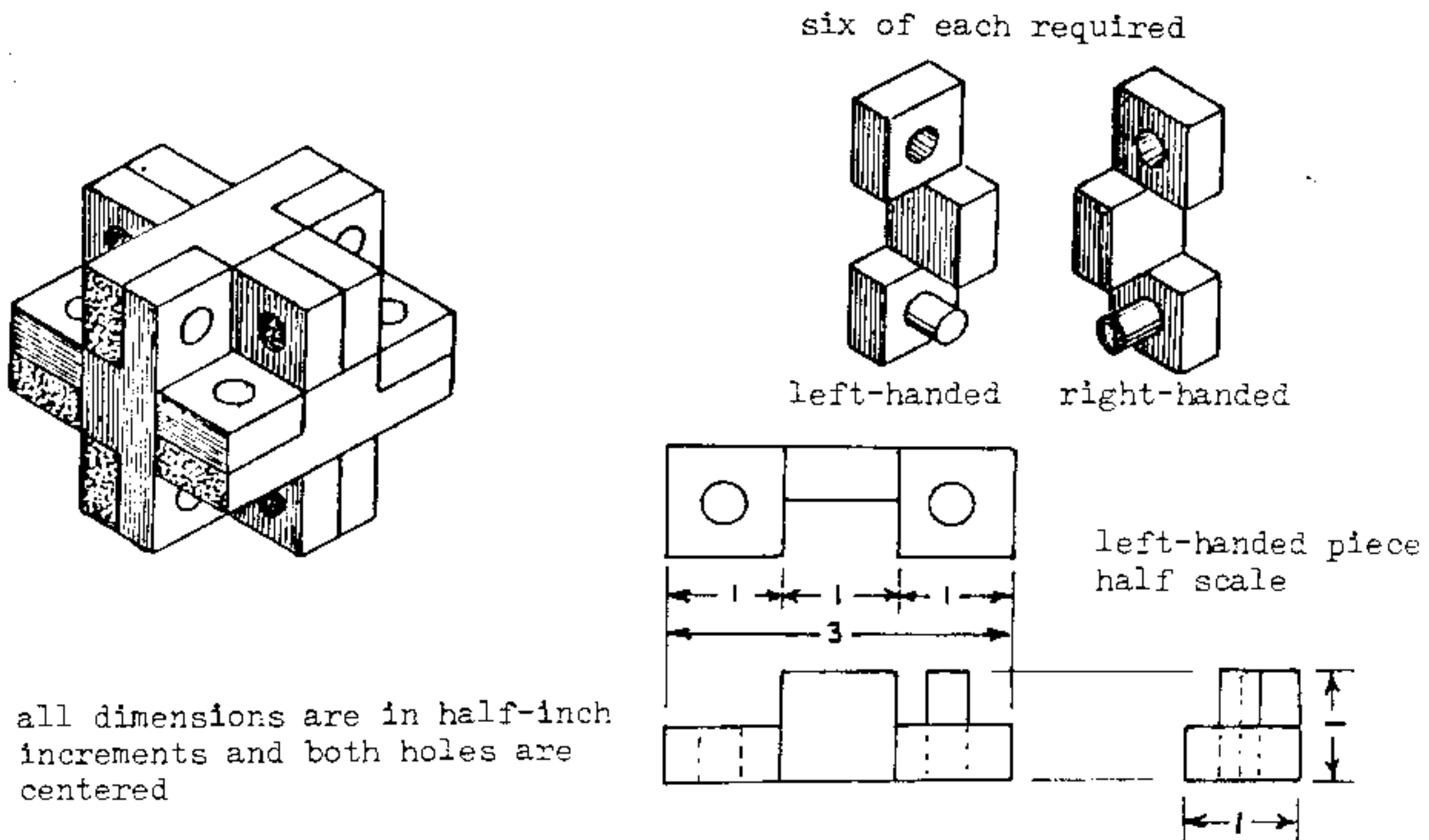

## Pin-Hole Puzzle

This puzzle is easy to make and easy to solve. Start with six blocks 1x1x3 inches. Drill and insert dowels as shown below. Refer to the Frantix Puzzle directions for dowels and drilling.

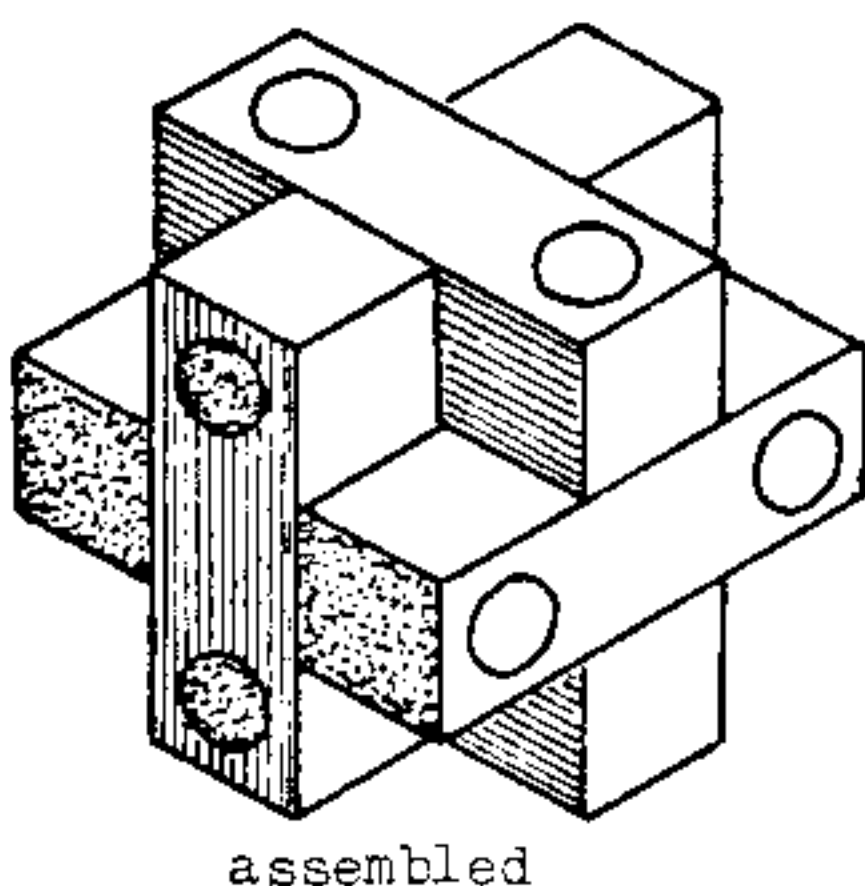
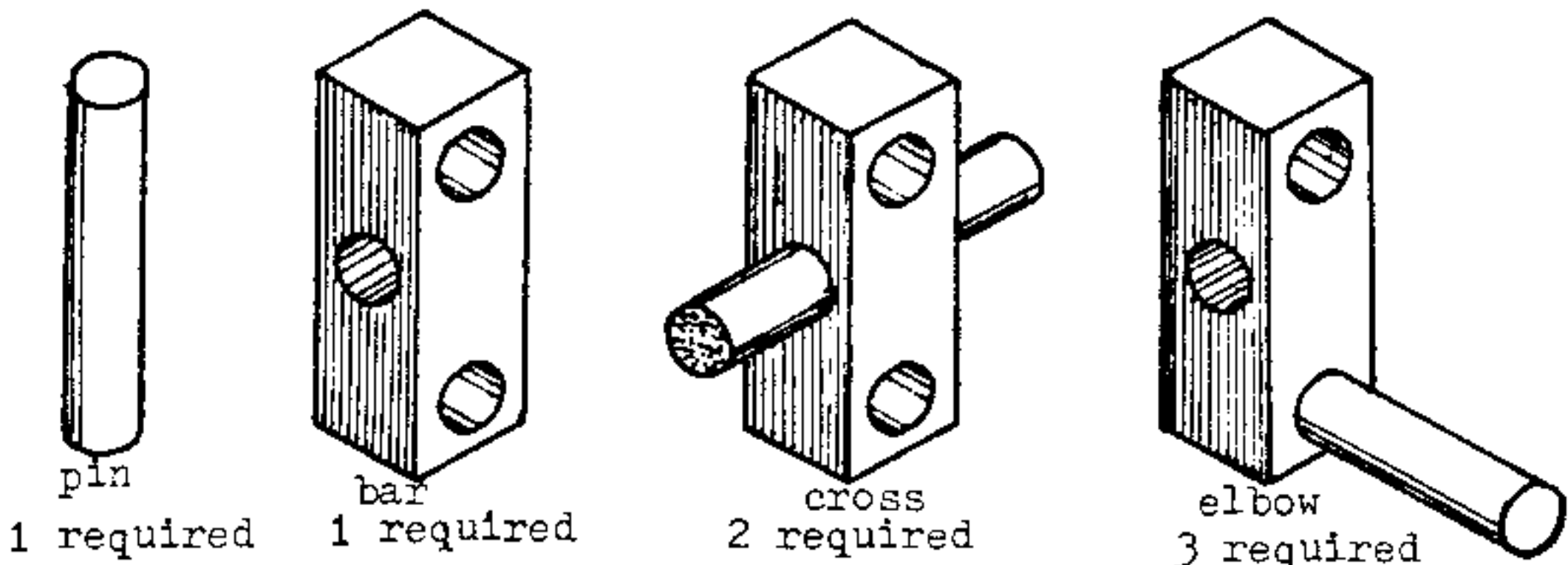

six dowels required, 3 inches long  
secure with brads

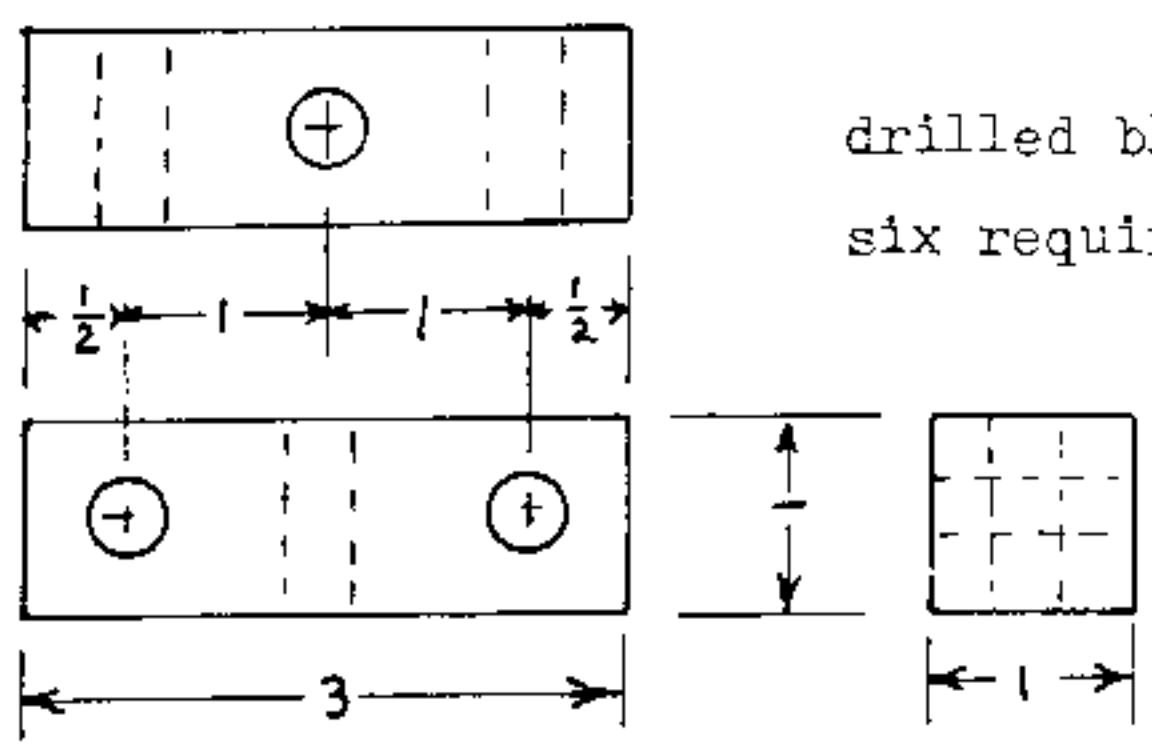

## Corner Block Puzzle

This is a variation of the Pin-Hole Puzzle, likewise fairly easy to make, quite attractive in contrasting hardwoods, and interesting to solve. The six dissimilar puzzle pieces are shown below. Follow the same instructions as for the Pin-Hole Puzzle, but then add the eight cubic blocks as shown. The best fit is obtained if the blocks are glued in place with the puzzle assembled. The six outside faces of the assembled cube can be sanded on a belt sander and brought to a fine finish. The puzzle has two solutions, one of which is shown.

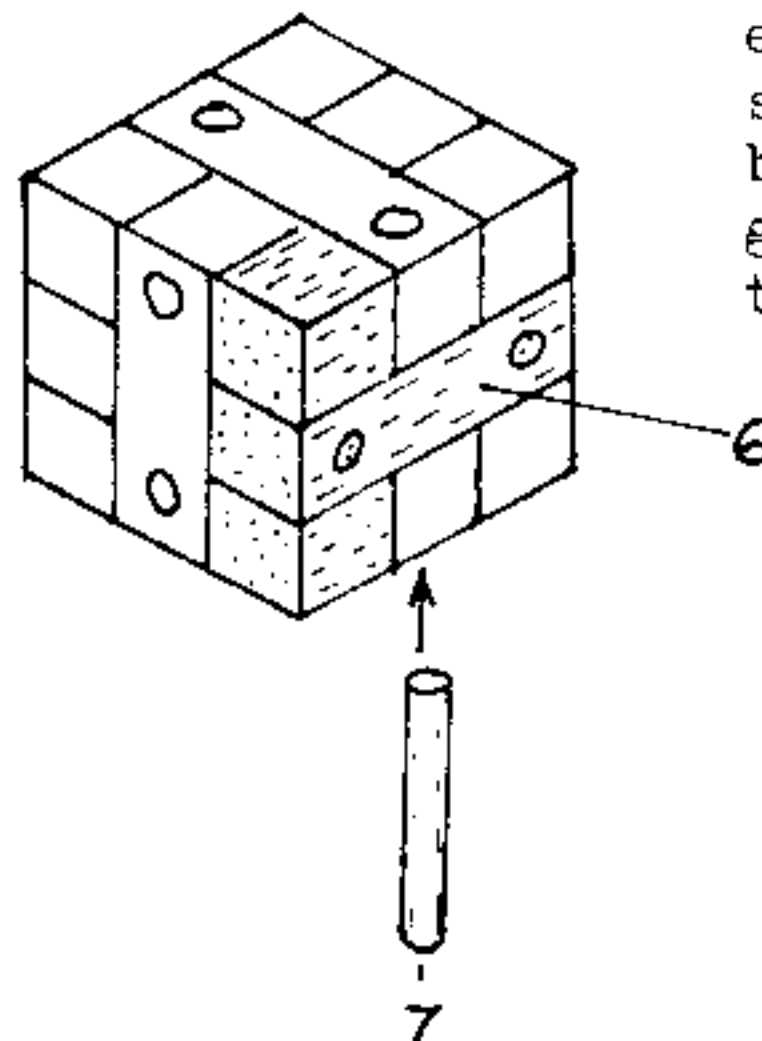
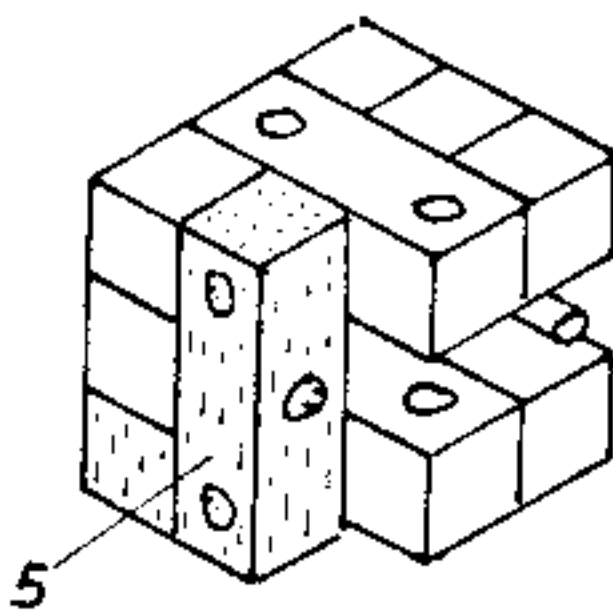
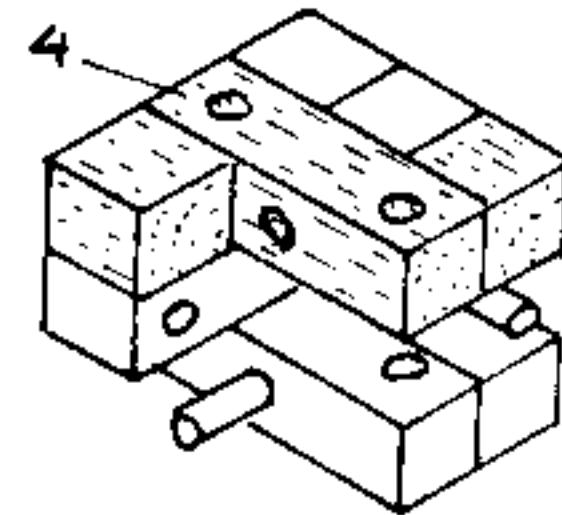
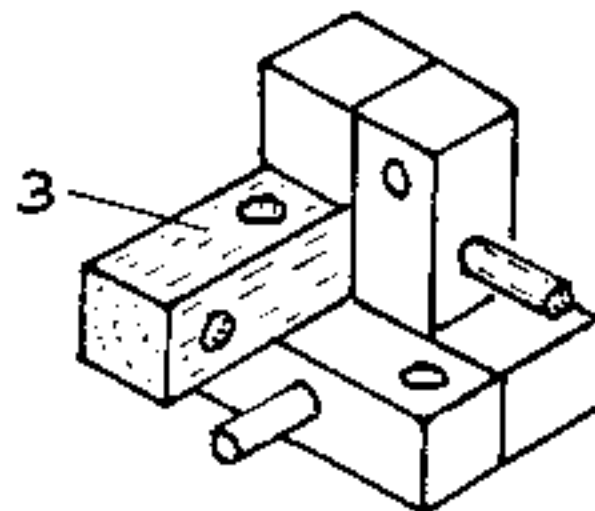
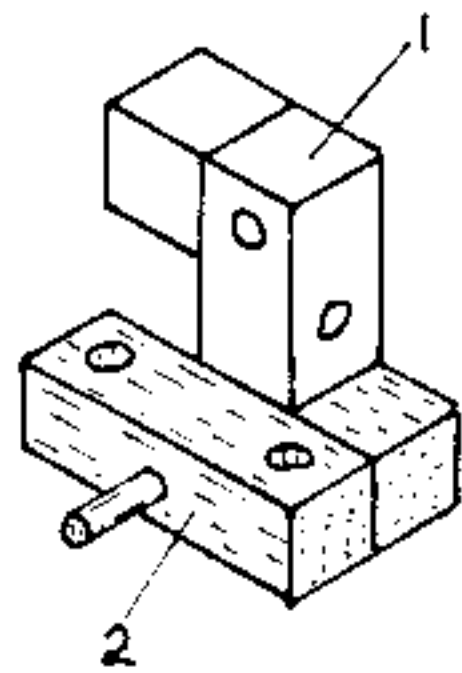
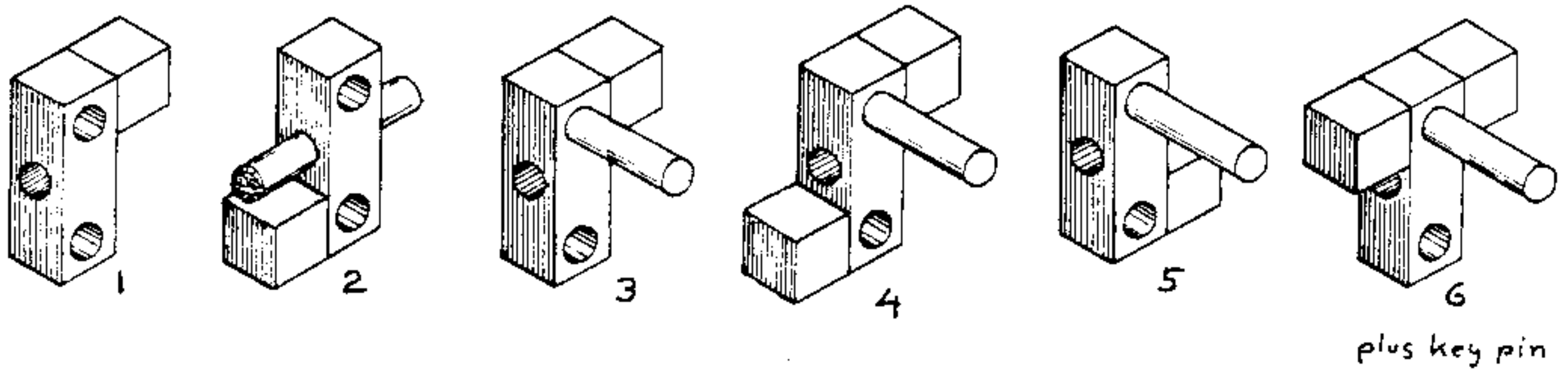

Start with one bar, one cross, and four elbows, assembled as shown. Then add corner blocks. Key pin (7) goes in last to complete the puzzle.

## Chapter 7 - Diagonal Burrs

All of the three-dimensional puzzles considered thus far have involved right angle cuts and cubic or rectangular blocks. The puzzles to be described next require 45-degree saw cuts using special jigs. Thus, they are a bit more trouble to set up, but well worth the extra work for those who enjoy the fascination of unusual puzzles with intriguing geometry. The simple projects in this chapter will lay the foundation for slightly more complicated ones in later chapters.

### Six-Piece Diagonal Burr

This puzzle has been around for over a century. As an assembly puzzle it is quite simple. It does have an intriguing geometry and is sculpturally attractive when well made of fine woods. It is also a good practice woodworking exercise.

Start with six sticks one-inch square (or scaled up or down as you wish). Saw a pair of accurate 45-degree  $\nabla$  notches in each piece as shown. How you actually do this notching is left to your ingenuity, depending upon what power tools and skills you have available. I have sometimes made these notches on a bandsaw, using a special  $\nabla$  cradle to hold the sticks at 45 degrees while sliding in the miter grooves of the saw. An alternate method using a table saw is shown on the next page.

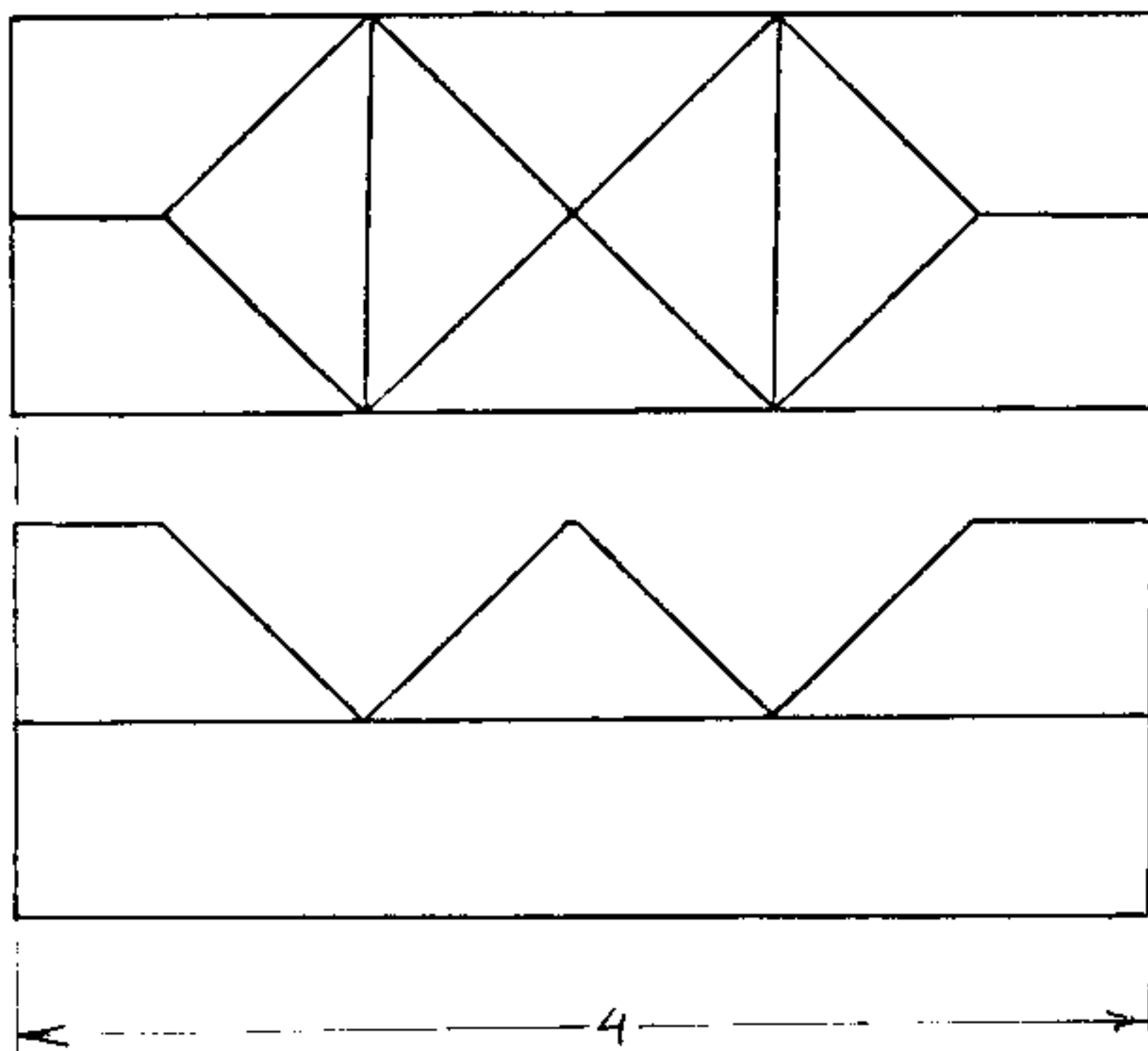

diagonal burr puzzle piece  
drawn full scale  
angles are 45 degrees  
six pieces required

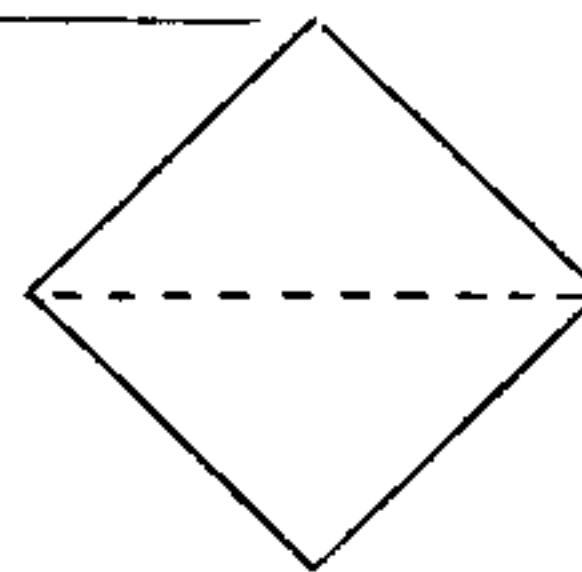

The puzzle is assembled by mating two halves of three pieces each. Some trial and error and sanding may be required to get just the right fit. Pieces that are slightly too loose may be combined with tight pieces to achieve a smooth fit. This configuration is very susceptible to changes in humidity, so a stable wood such as mahogany is recommended.

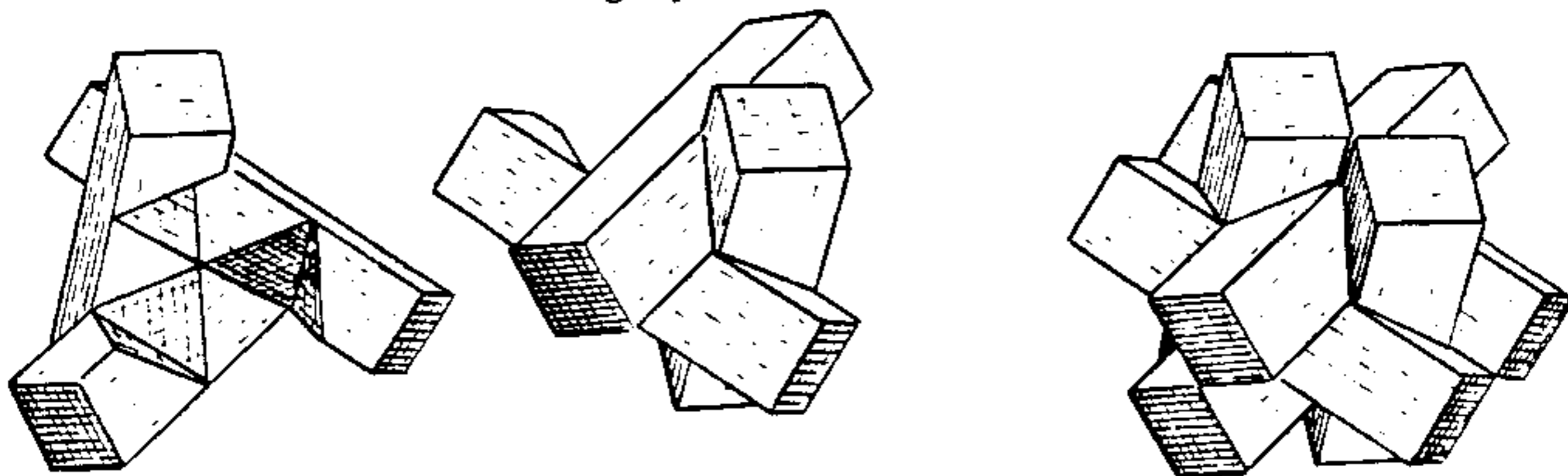

### Diagonal Saw Jig

An alternate method of making the Six-Piece Diagonal Burr involves the use of a special jig we shall call the diagonal saw jig. This very useful tool opens the door to a whole new world of polyhedral puzzle designs, some of which are shown on the cover. It is not difficult to make, but much trouble will be saved by making it carefully and getting all the angles right.

The base of this jig is a piece of stable plywood at least a foot square. It slides in the miter grooves of your table saw on a pair of rails glued to the underside. Attached onto this base is a V shaped cradle which holds the one-inch square stock at a 45-degree angle of rotation and feeds it into the saw at a 45-degree angle as viewed from above. See drawing below.

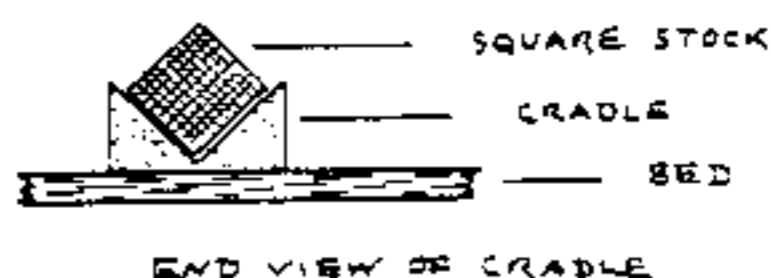
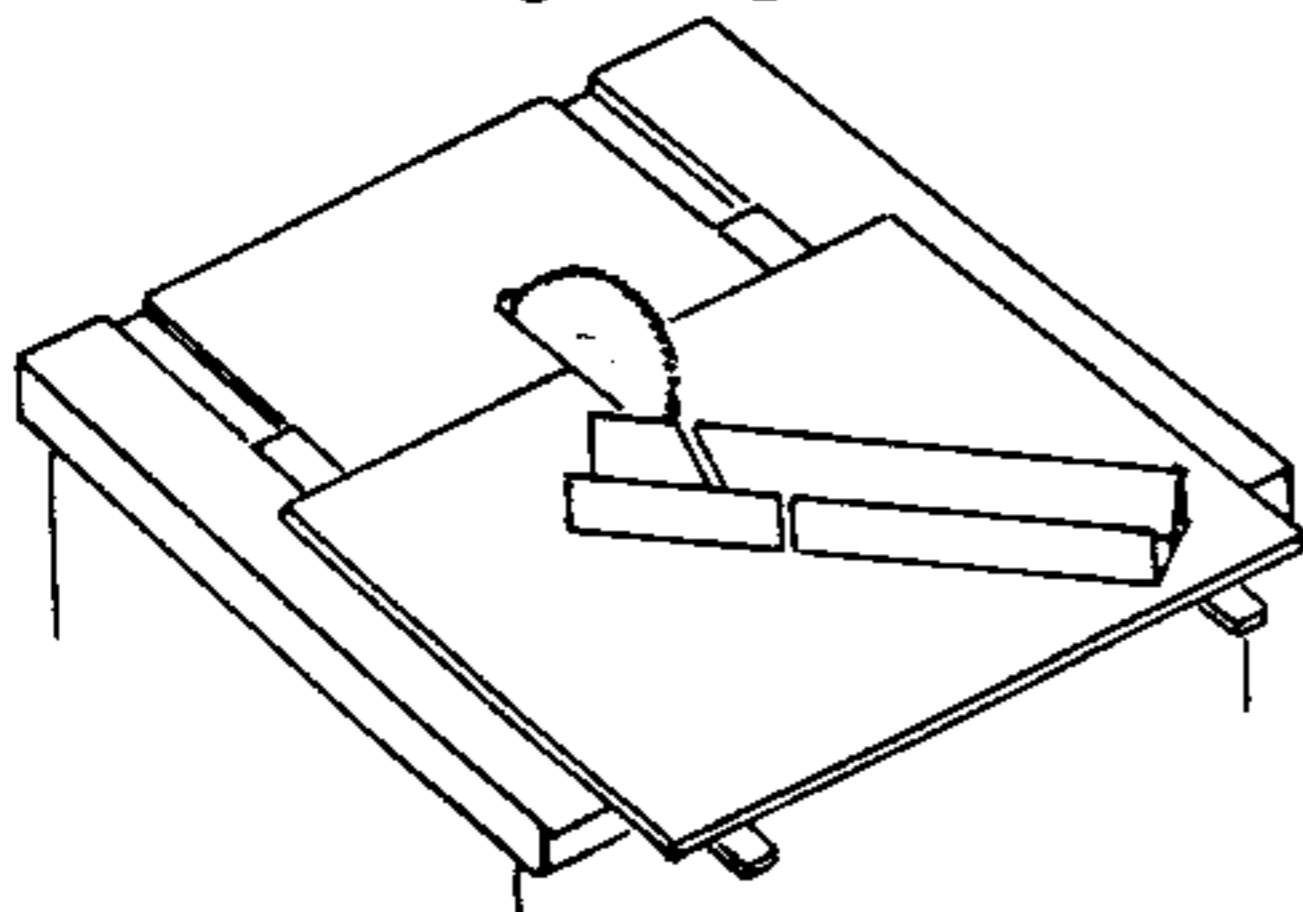

Before gluing the parts of the jig together, you may want to use screws and provide for slight adjustments to get the angles just right. The purpose of the jig is to make accurate 45-degree diagonal cuts on the end of the square stick. Saw two such sticks, bring them together, and see if they add up to an exact right angle. Make adjustments if necessary until they do.

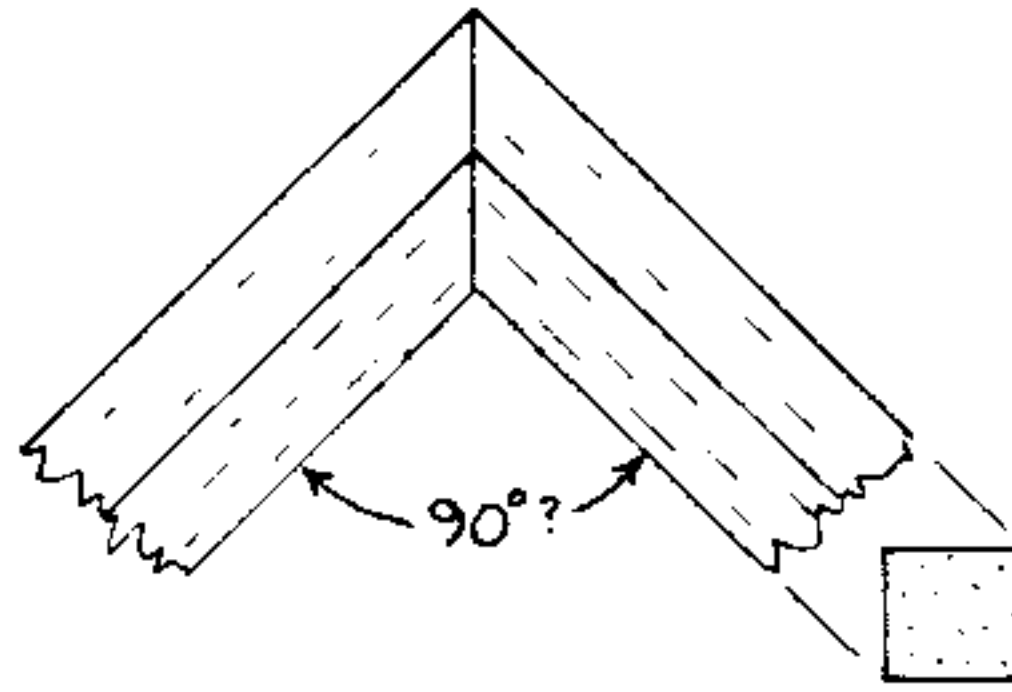

The pieces for the Six-Piece Diagonal Burr can be made using this jig from three blocks glued together - an octahedral center block and two diagonal end blocks. To make the octahedral center block, make a diagonal cut on the end of a one-inch square stick. Rotate the stick 180 degrees in the cradle and saw again. This brings the end to a wedge point. By advancing the stick just the right distance and making two more saw cuts, an octahedral block is produced, see below. The diagonal end blocks are made by first making a diagonal cut on the end of the stick and then sawing off square. Glue the three blocks together using a V shaped gluing jig to hold them in alignment. Sand if necessary. See previous instructions for fitting and assembly.

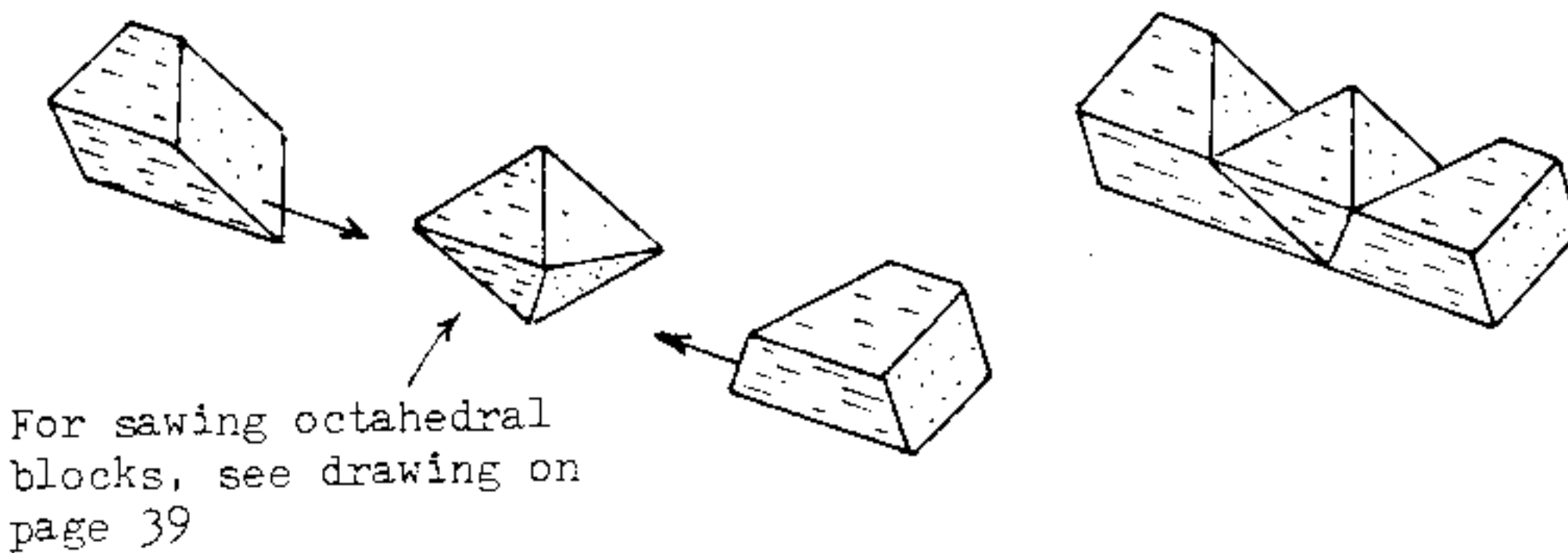

## Star Puzzle

This next puzzle is but a slight variation of the Diagonal Six-Piece Burr, yet it looks quite different and has the geometrical shape of a stellated rhombic dodecahedron. It is easily made using the diagonal saw jig.

Start with about two feet of one-inch square stock. Make a diagonal cut on the end, rotate the stick 180 degrees in the cradle, advance it, and make a second cut to produce the six-sided center block, as shown. To make the pair of tetrahedral end blocks, follow the same procedure but advance the stick a shorter amount for the second cut. To saw these blocks with any sort of repetitive accuracy, do not rely on your eye or pencil marks, but rather install some sort of mechanical stops in the jig. It may take some trial and error to get them just right.



too long



too short



just right

Sawing the six-sided center block

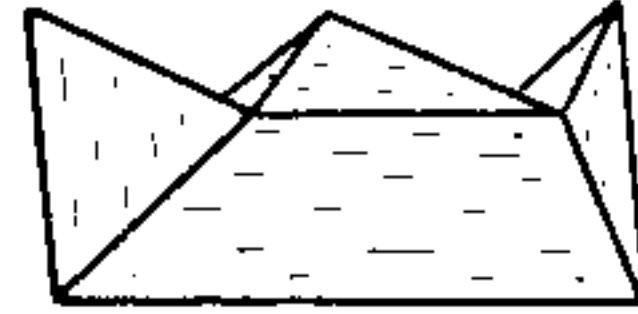

To glue these blocks together accurately, make a simple gluing jig out of five one-inch square blocks about 4 inches long, as shown below. The three center blocks are the working part. The two outside blocks serve as legs. For fitting and assembly, see previous instructions.

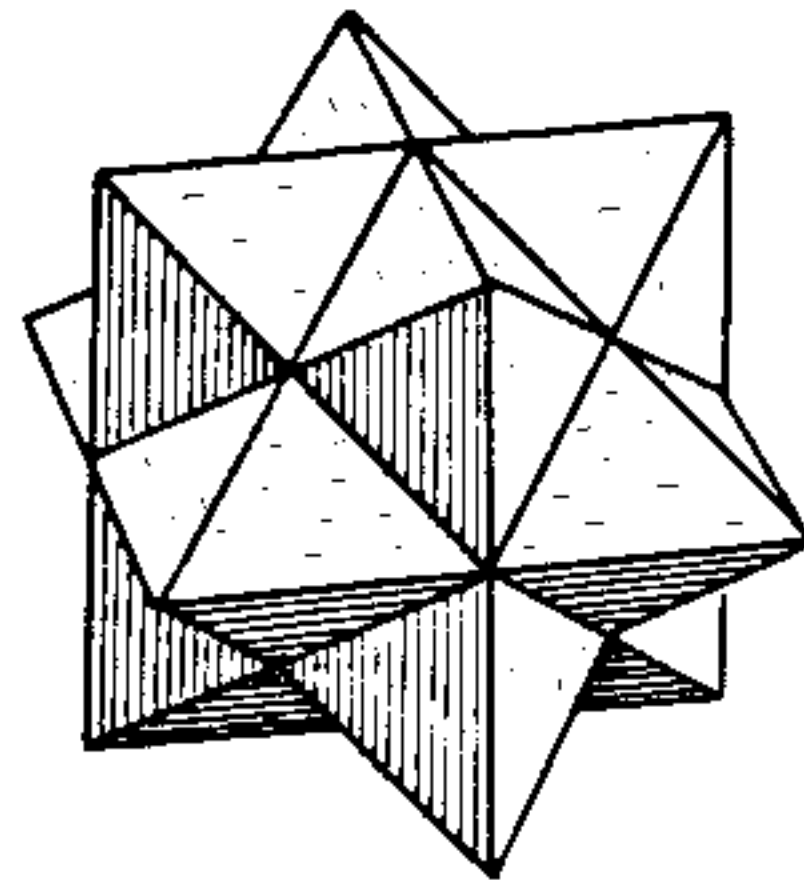
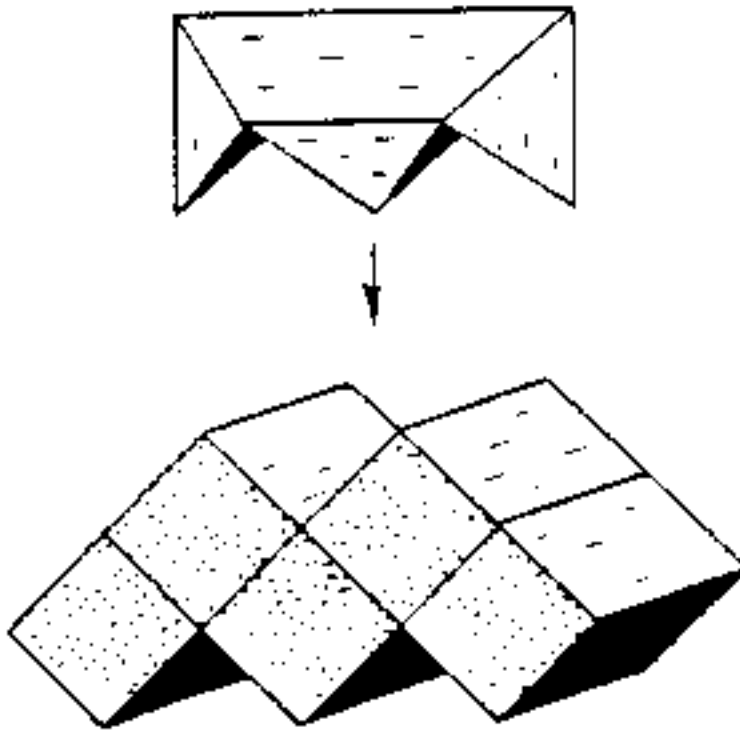

### Four Corners Puzzle

If you have successfully made the Star Puzzle, this one should be easy. Again make six of the six-sided center blocks as before. The six pairs of identical end blocks are likewise made using the diagonal saw jig. After each cut, rotate the stock 90 degrees always clockwise and advance it so as to saw off a five sided block without waste, as shown. Glue together as before. Like all puzzles in this family, it is easily assembled by mating two halves of three pieces each. It is perhaps more of an intriguing interlocking geometrical sculpture rather than a puzzle.



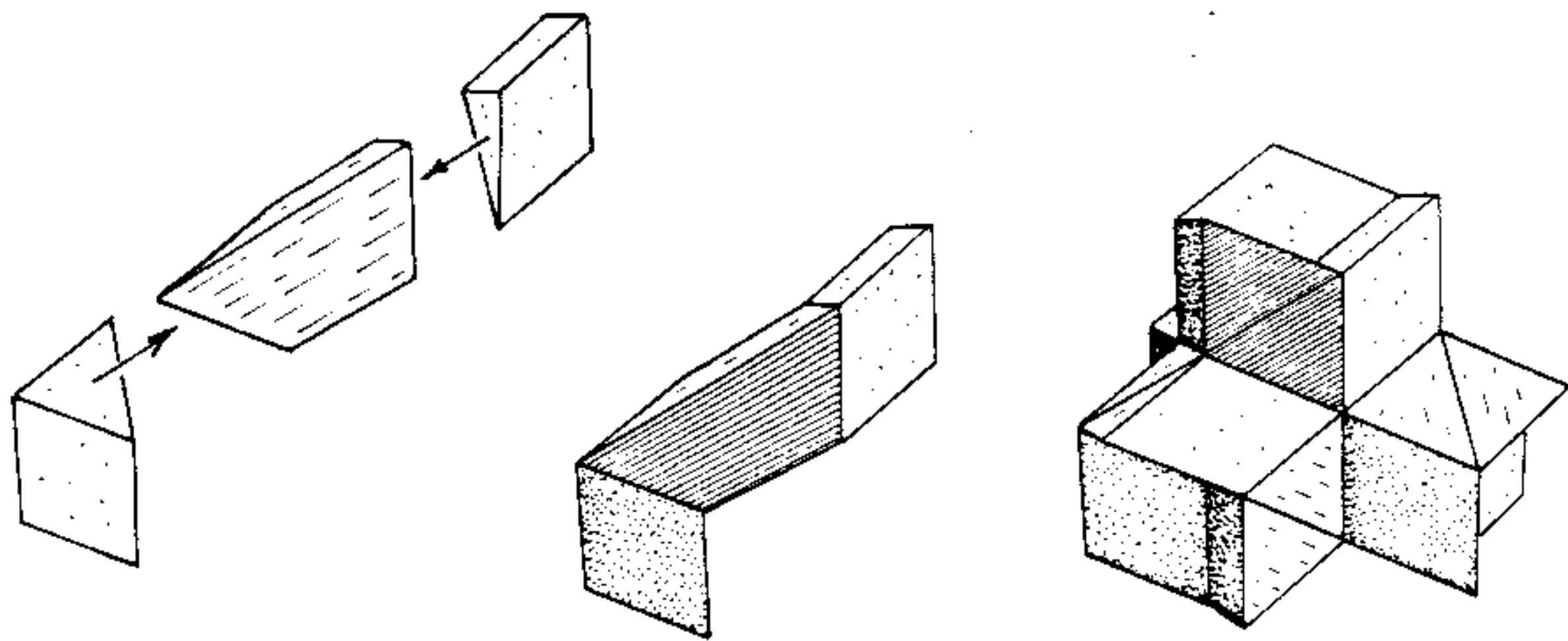

An interesting variation of this puzzle is to make the end blocks of four contrasting woods, as shown below. The object of the puzzle then is to assemble such that each of the four corners of the assembled puzzle is a solid color.

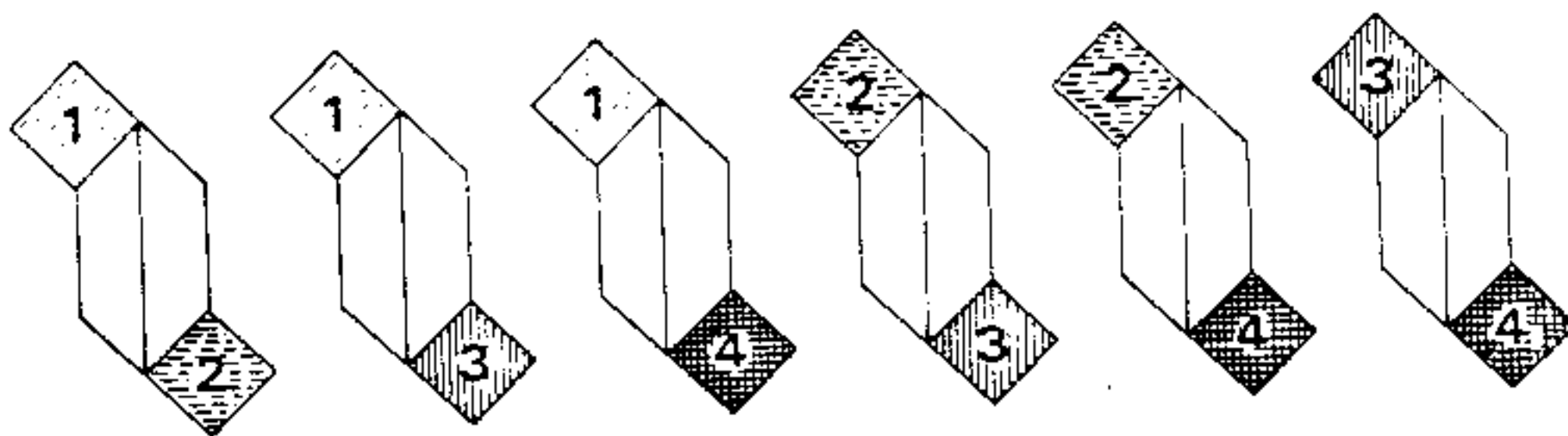

Shown below is a method for sawing the octahedral blocks from square stock, using the diagonal saw jig on page 36. The first two cuts bring the end of the stock to a wedge point. Then advance the stock approximately 1.5 inches if using one-inch square stock, the exact measurement to be determined by inspection. The third cut goes only halfway through. The fourth and final cut severs the block. These blocks are used in the Six-Piece Diagonal Burr (page 37) and the Peanut Puzzle (page 40).

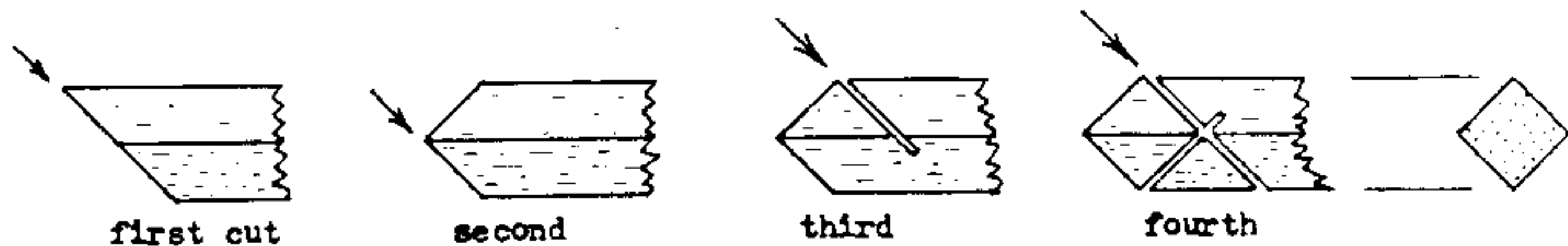

## Chapter 8 - Puzzles with Polyhedral Blocks

### Peanut Puzzle

In the preceding chapter, it was shown how to saw octahedral blocks from square stock using the diagonal saw jig. This puzzle uses 36 such blocks. These are first glued together in threes. The first one glued accurately and waxed serves as a gluing jig for the others. They should mate with each other rather loosely to allow for slight errors in assembly. Use paper shims if necessary while gluing. Then these half-pieces are joined together according to the drawings below.

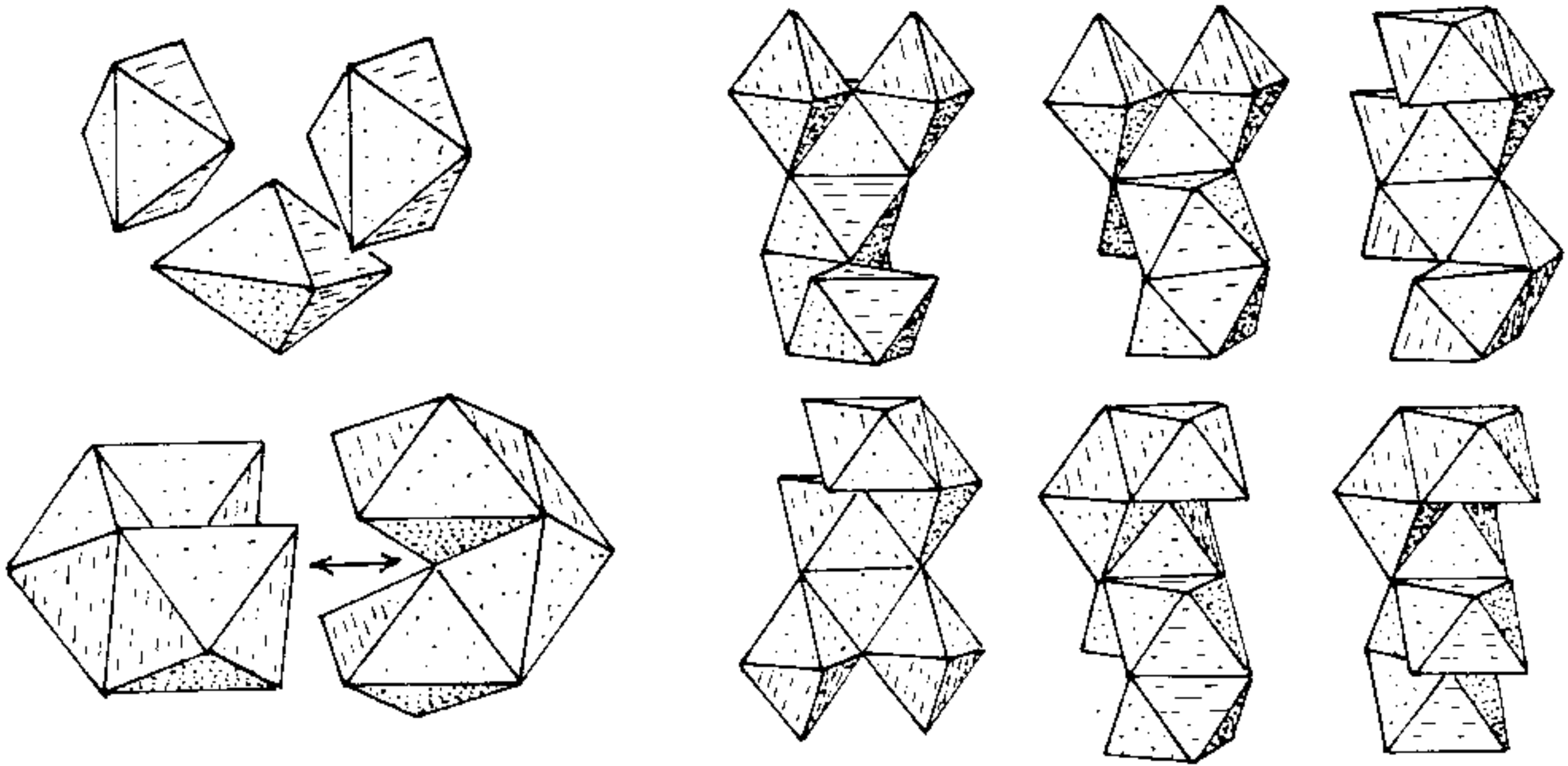

The object of this puzzle is to join the pieces together in a closed loop to construct all sorts of different geometrical figures, such as those shown below, using three, four, five, or all six pieces. Or you can invent your own. The pieces are fun to just play with. In order to fit together all different ways, the pieces must be very accurately made, so this is not a project for the beginner.

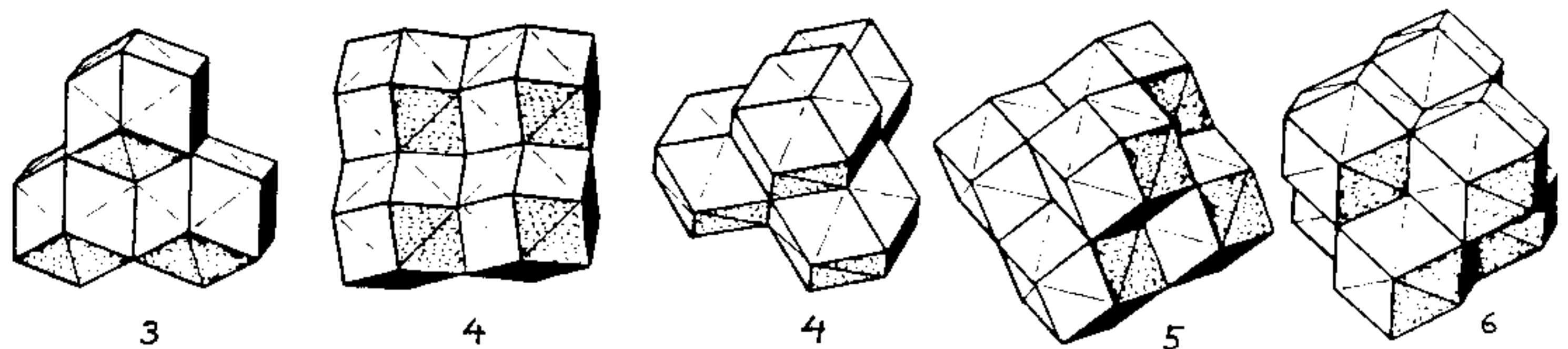

## Eight-Piece Cube Puzzle

The Peanut Puzzle just described is fun to play with if accurately made, but it is not easy to make. This next puzzle is just as entertaining and somewhat easier to make. It is described and well illustrated in the Dec. 1991 (#91) issue of *Fine Woodworking*. I produced them at one time with the name "Pieces of Eight Puzzle."

Start with about 6 feet of uniform stock having a right-isosceles-triangular cross-section, as shown below. This is easy to make by ripping unwarped lumber with the saw tilted 45 degrees. Never mind if the lumber is too thin and the right angle edge is beveled slightly. Then make two 45-degree cross-cuts to produce a square pyramid block. Note that when sawing out small blocks with intricate shapes, they are always sawn from the end of a length of stock, so that it is never necessary to hold them with your fingers dangerously near the saw blade. Check carefully for accuracy and squareness. Six of them should fit together to form a cube. You will need 48 such blocks. Glue them together in threes to make half-cubes. The first half-cube, accurately made and well waxed, serves as a gluing jig for the other 15 half-cubes. Any two half-cubes should fit together slightly loosely to form a cube. At this point, you may wish to uniformly bevel the outside edges at 45 degrees for aesthetics. Then join them accurately in pairs to make the eight dissimilar puzzle pieces, as shown.

The eight pieces fit together without great difficulty to construct a cube. There are several solutions. Many other interesting shapes can be constructed using four, six, or all eight pieces. They are great fun to just play with. You may even be inspired to make larger sets and invent your own puzzle problems.

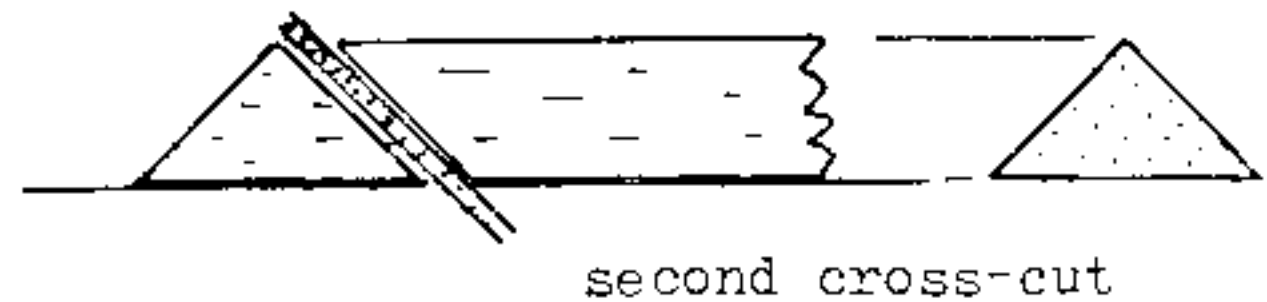
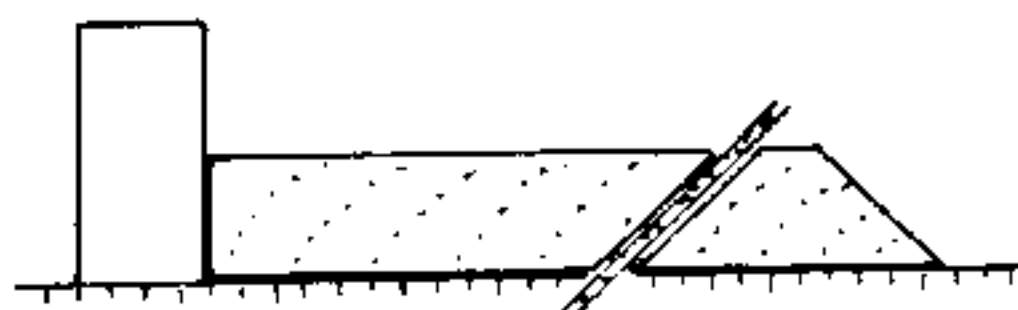
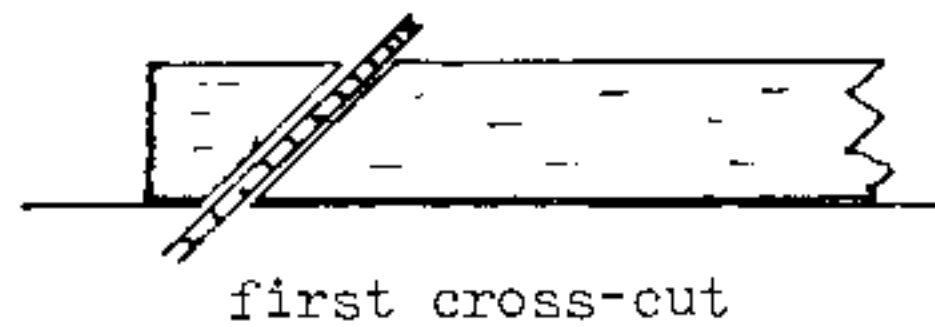
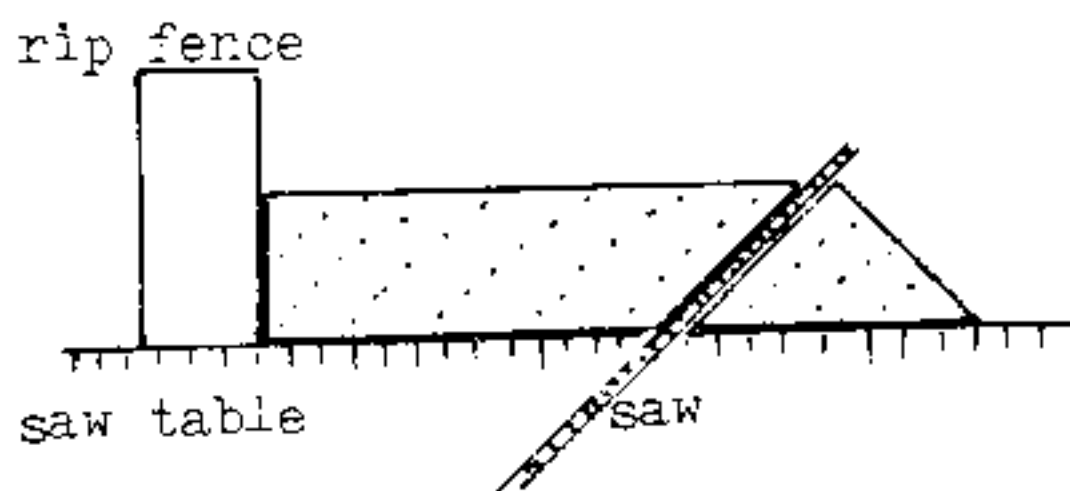

alternate method with thin lumber makes truncated square pyramid

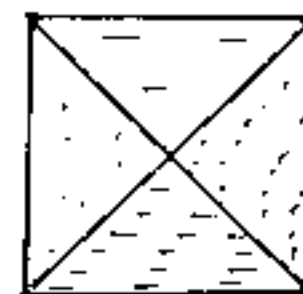
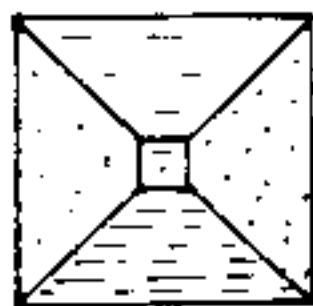

square pyramid block

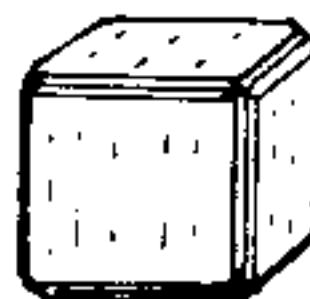
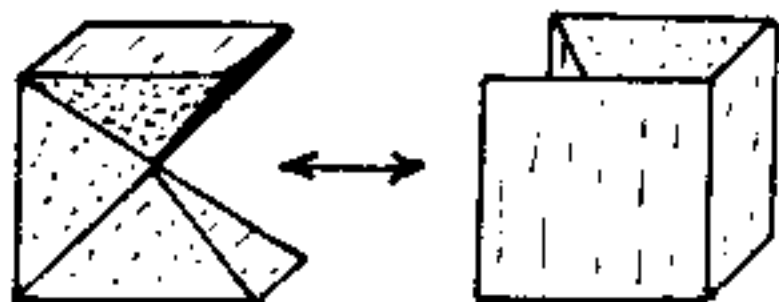
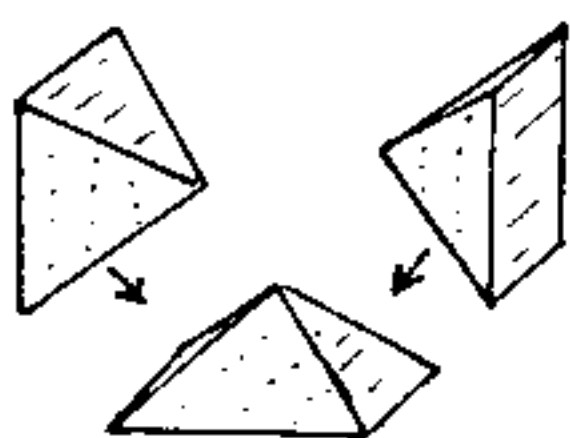

optional - bevel edges

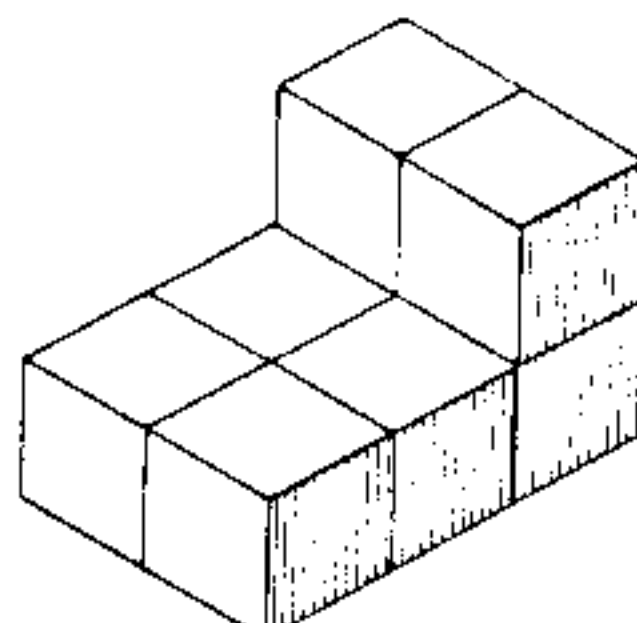
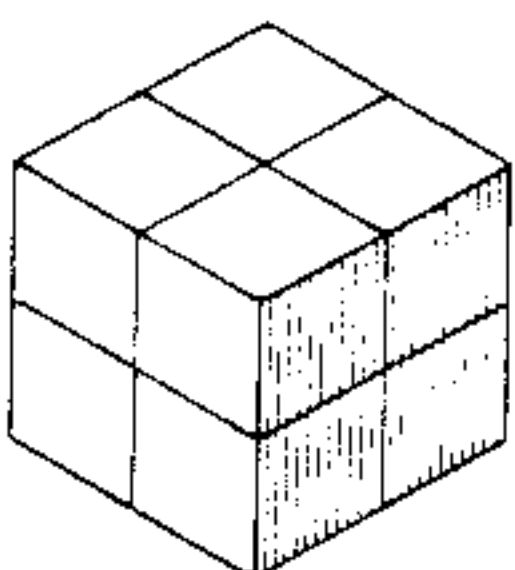
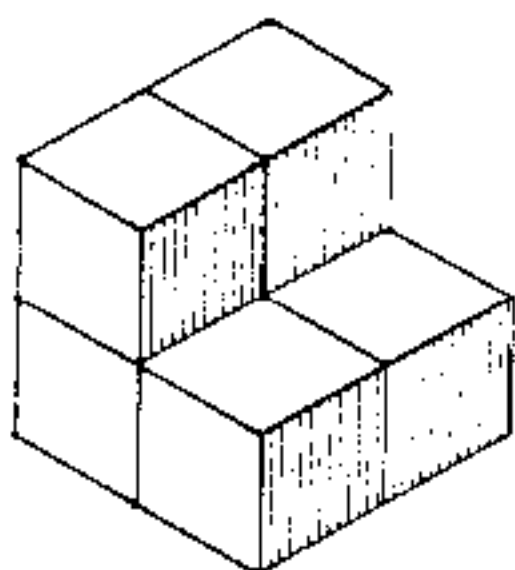
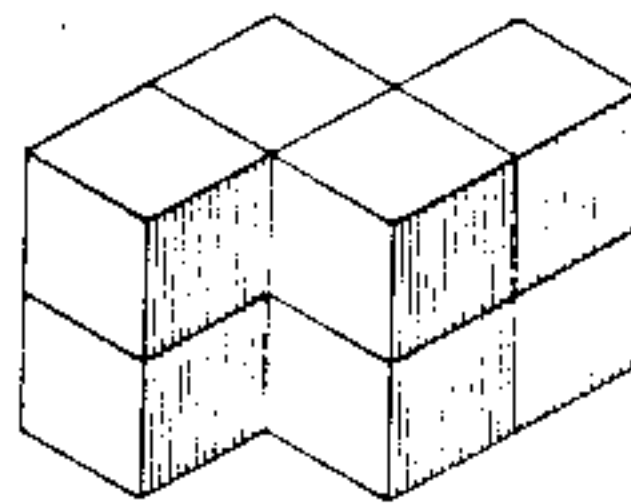
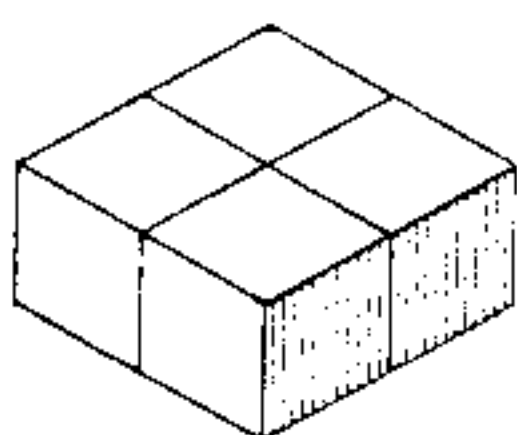
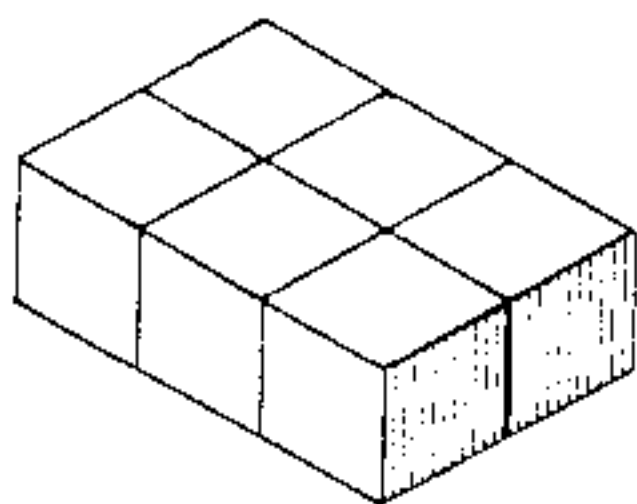
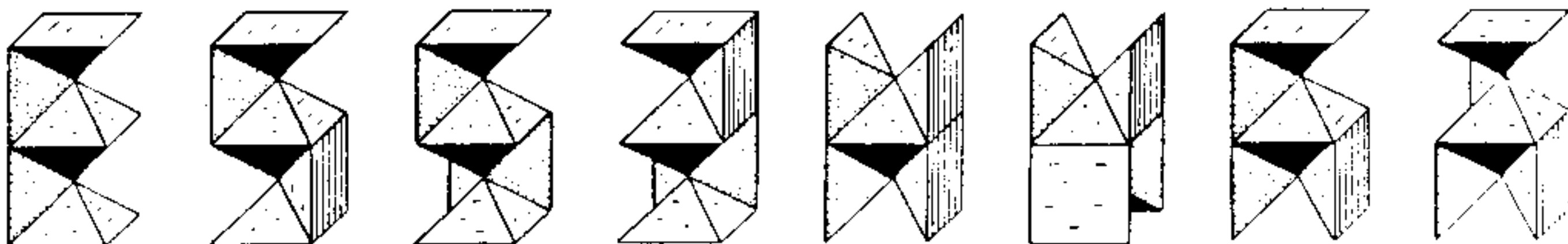

## Four-Piece Pyramid Puzzle

The next two puzzles use twelve-sided blocks called rhombic dodecahedra. These blocks are fairly easy to make from one-inch square stock using the diagonal saw jig. Make four diagonal cuts on the end of the stock, rotating 90 degrees between cuts but not advancing the stock. This brings the end to a pyramidal point. Then advance the stock 1.414 inches plus allowance for the kerf of the saw and make four more cuts, the first three of which go only halfway through. The resulting block should measure exactly one inch across all flats. Adjust the sawing until it does. The easiest way to do this is with a slightly modified version of the diagonal saw jig, in which a stop block is fixed at the other (near, right) end, and spacer blocks are dropped in as shown below. If all this sounds too complicated, see a simpler alternate version a couple pages ahead.

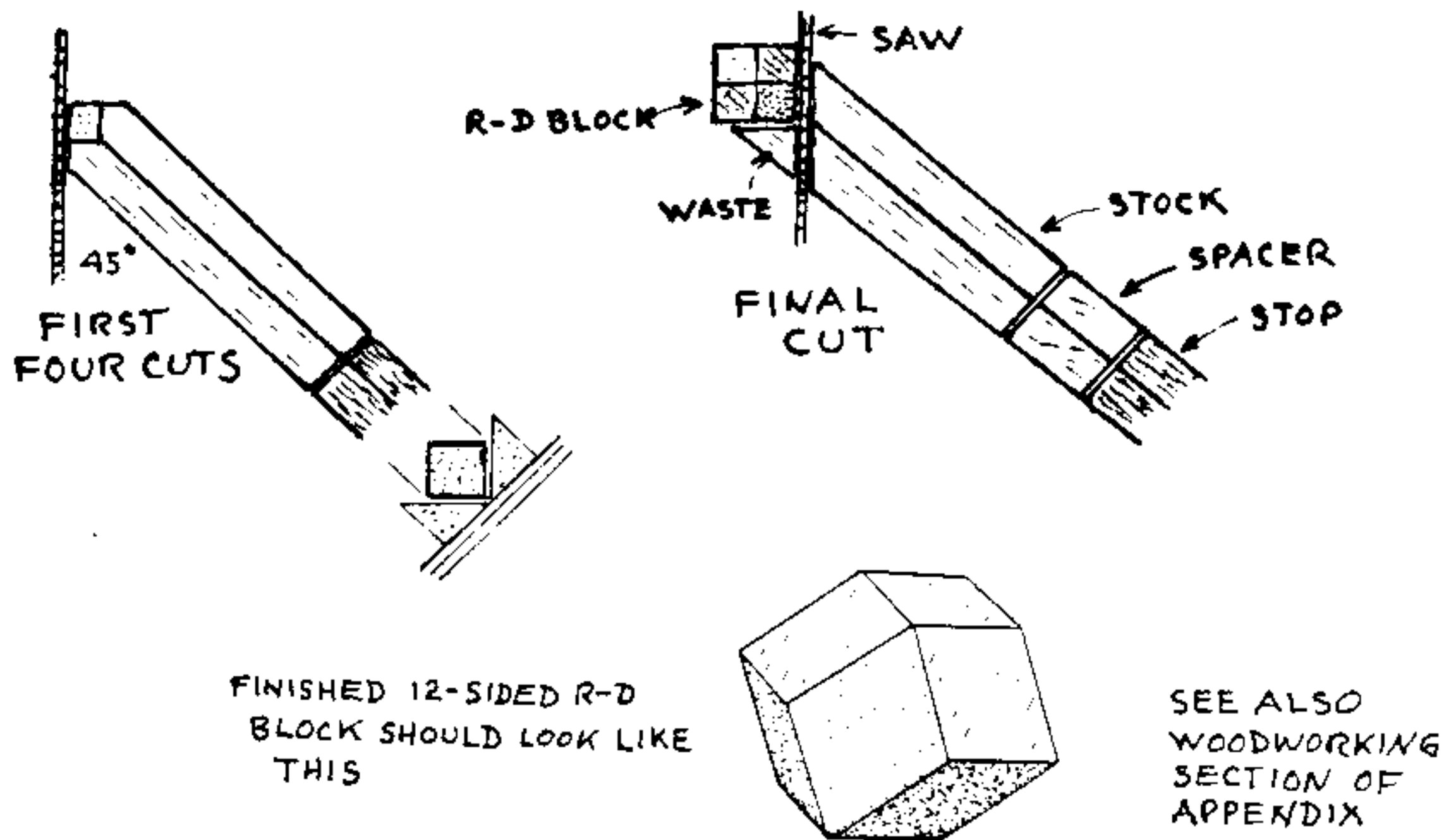

After having checked twenty such blocks for accuracy and uniformity, double check by assembling them into a pyramidal pile held together with rubber bands. Now remove the top three layers, leaving a triangular bottom layer of ten blocks, still held tightly with a rubber band. Number the blocks as shown. Glue together all blocks with like numbers. Now place the second layer of blocks on top of the bottom layer and continue gluing like numbered blocks together. Use wax or bits of aluminum foil to prevent accidental joints. Continue until all blocks are glued in fives to form four puzzle pieces. The puzzle assembles in one order only, and the pieces are numbered in order of assembly. Therefore, when disassembling, piece 4 must come out first, then piece 3 next. This puzzle is rated very confusing to assemble, even knowing the correct order.

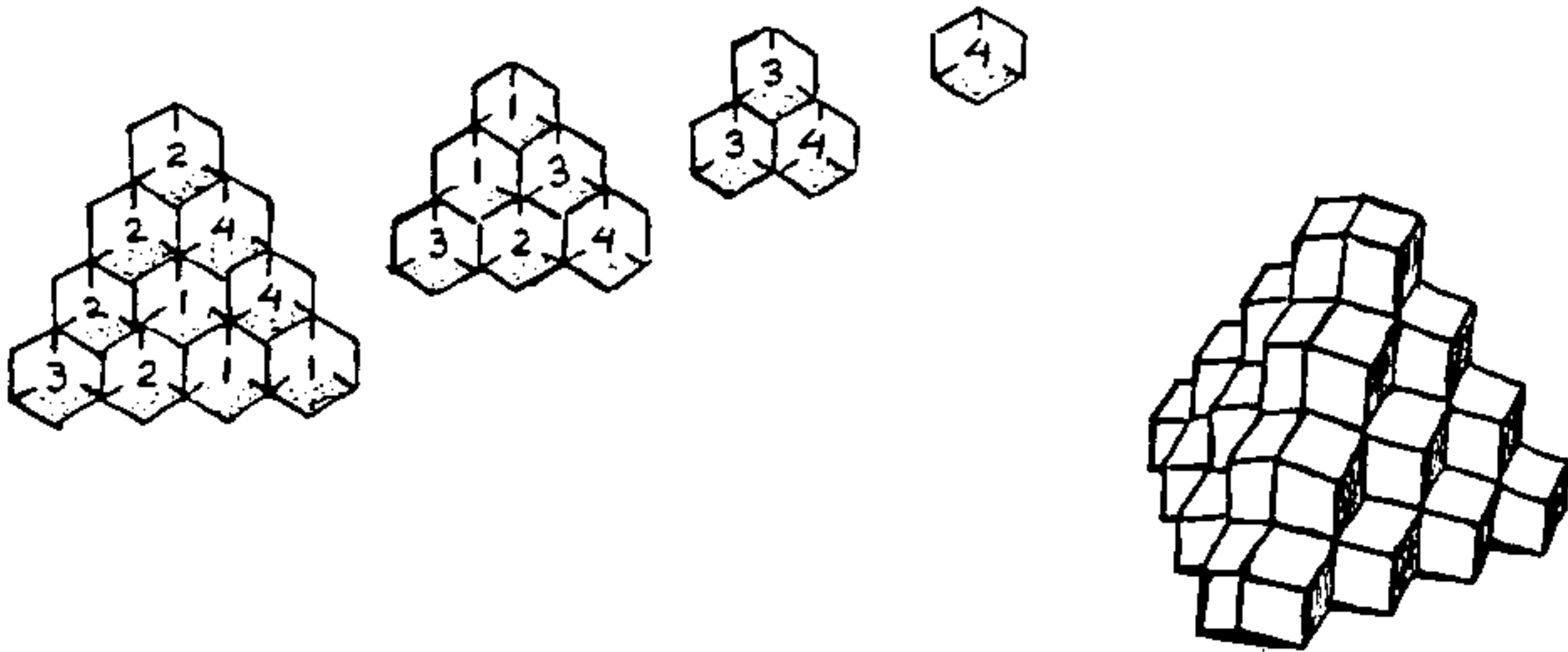

### Octahedral Cluster Puzzle

This puzzle likewise uses rhombic dodecahedral blocks, nineteen of them. It likewise has four puzzle pieces, only one order of assembly, and only one extremely confusing solution. Follow the same directions as above, except start gluing the hexagonal seven block middle layer first, held with rubber bands, and then add the triangular top and bottom layers. Again, piece 4 must come out first, then piece 3. The model of this puzzle shown on the cover was made with 1.25-inch limba. The larger blocks are somewhat easier to work accurately. Note also that a better fit is usually obtained if the blocks are oriented with their grain all running in the same direction.

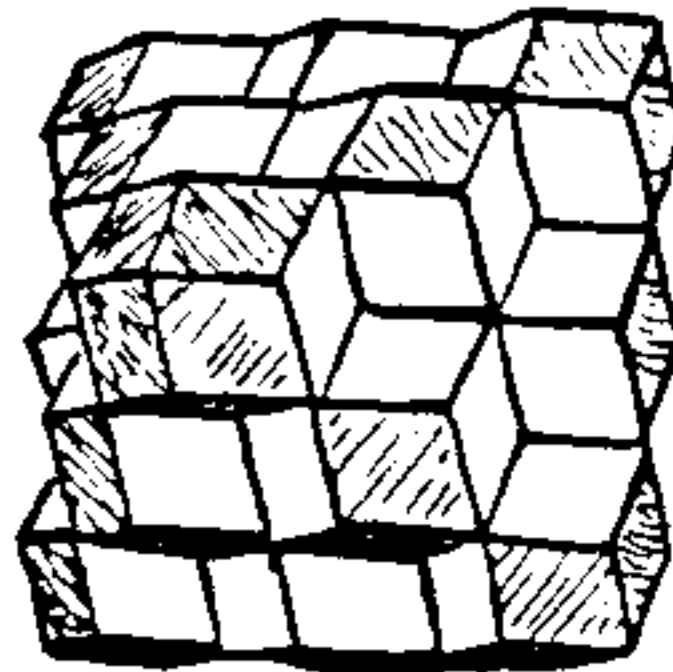
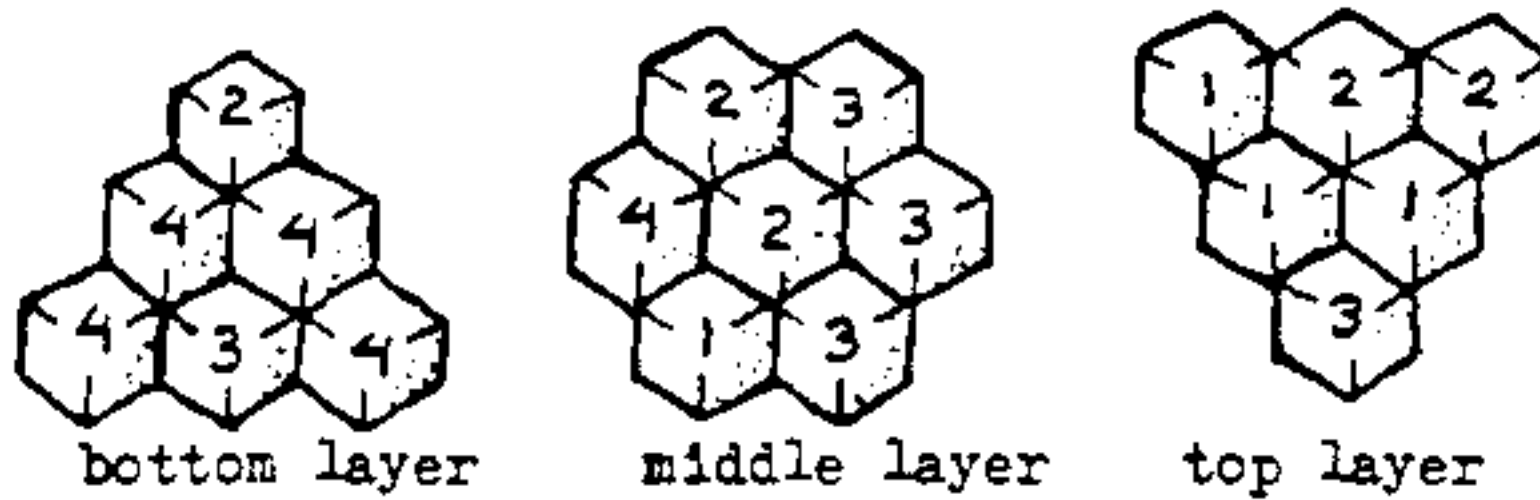

## Alternate Versions with Edge-Beveled Cubes

There is an easier way to make both the Four Piece Pyramid Puzzle and the Octahedral Cluster, and that is with edge-beveled cubes. Start with a set of uniform cubic blocks of around 1.25-inch size. Tilt the table saw at 45 degrees, lower the saw until it is flush with the table, fasten down a guide block as shown below, and then raise the saw until it cuts into the guide block. Wax the guide block and saw table. Now you can trim the twelve edges of the cubic blocks quickly and easily by running them through the saw. Watch out for your fingers! This is not a job for beginners. When the guide block is adjusted properly, the profile of the blocks will be approximately a regular octahedron, as shown. With a shallower bevel, the glue joints will be weaker. With a deeper bevel, the blocks will be hard to hold and saw accurately. The Four-Piece Pyramid Puzzle shown on the cover was made of edge-beveled 1.20-inch cubes of Honduras mahogany, with doweled joints.

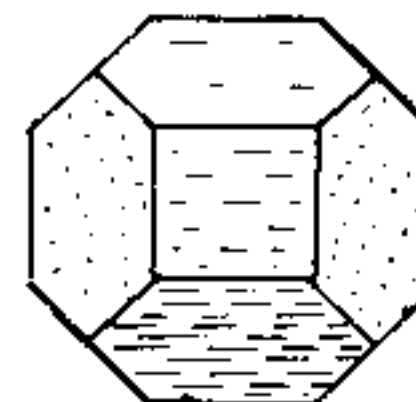
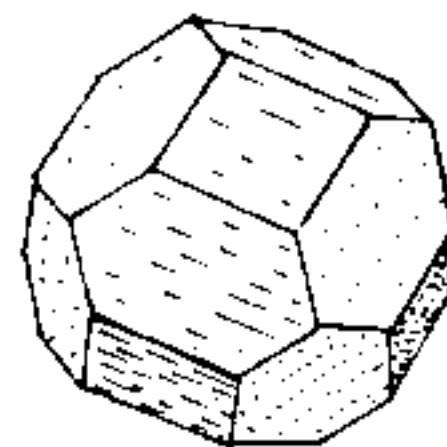
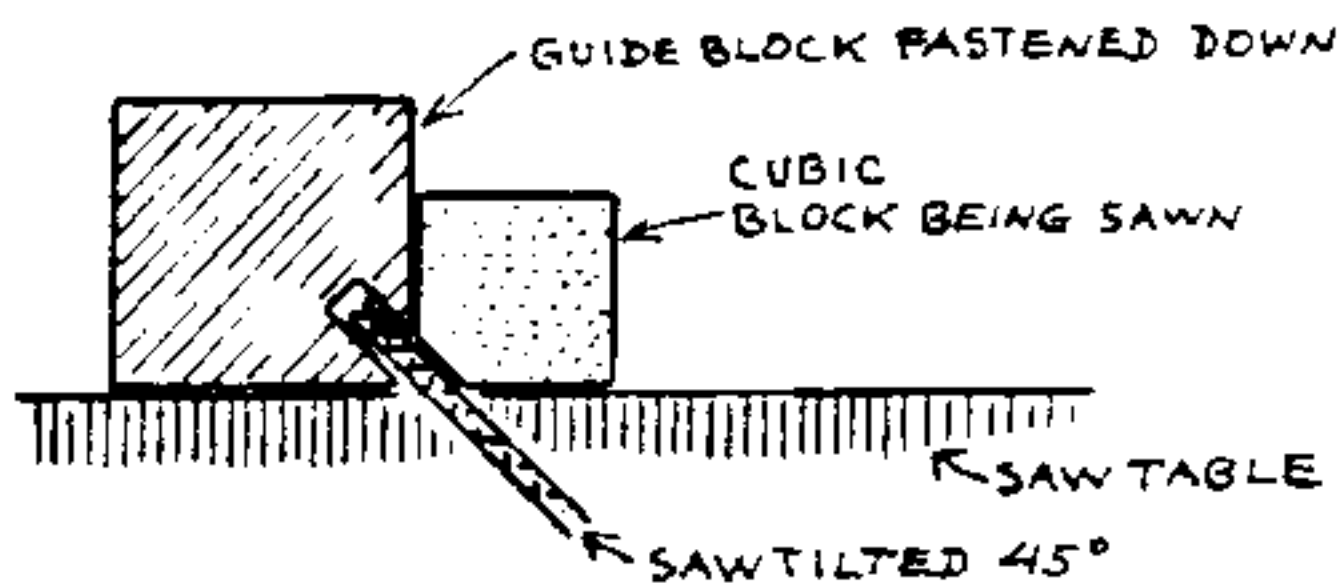

## Distorted Cube Puzzle

This puzzle uses fourteen edge-beveled cubes made from one-inch cubic blocks. This time, care should be taken in adjusting the guide block so that the width across the beveled edges, measured with calipers, is one inch also. Glue up the four puzzle pieces carefully as shown below.

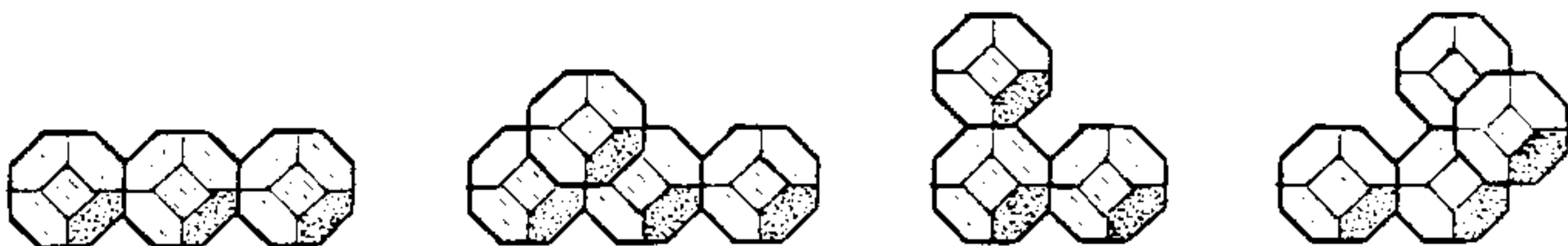

One object of the puzzle is to pack the four pieces neatly and symmetrically inside a 2.5-inch cubic box. A second and more difficult task is to pack them inside a rectangular box 2.5 x 2.1 x 3.1 inches. The tricky box shown below makes both sizes depending upon whether the cover is laid flat or stood on end in the slot in the bottom of the box. The pieces can also be assembled into a square pyramidal pile and other interesting constructions of your own invention.

(I made only six copies of this unusual puzzle, of which three went to my children and the other three to puzzle collectors here and abroad. Perhaps someone else will produce a few of them.)

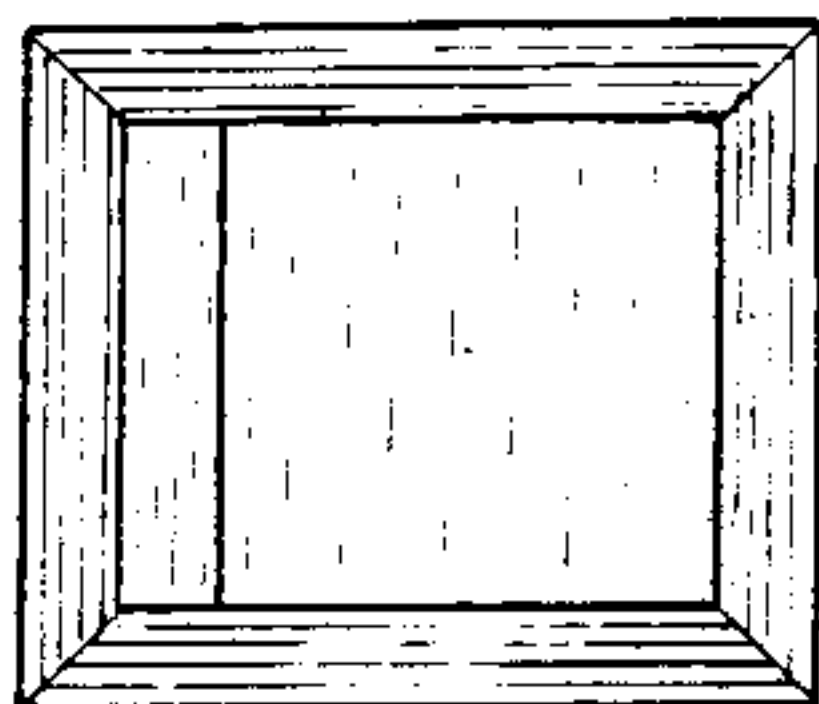

TOP VIEW  
OF BOX

$\frac{1}{2}$ -INCH CABINET-  
GRADE PLYWOOD

DRAWINGS ARE  
HALF SCALE IF  
USING ONE-INCH  
CUBIC BLOCKS

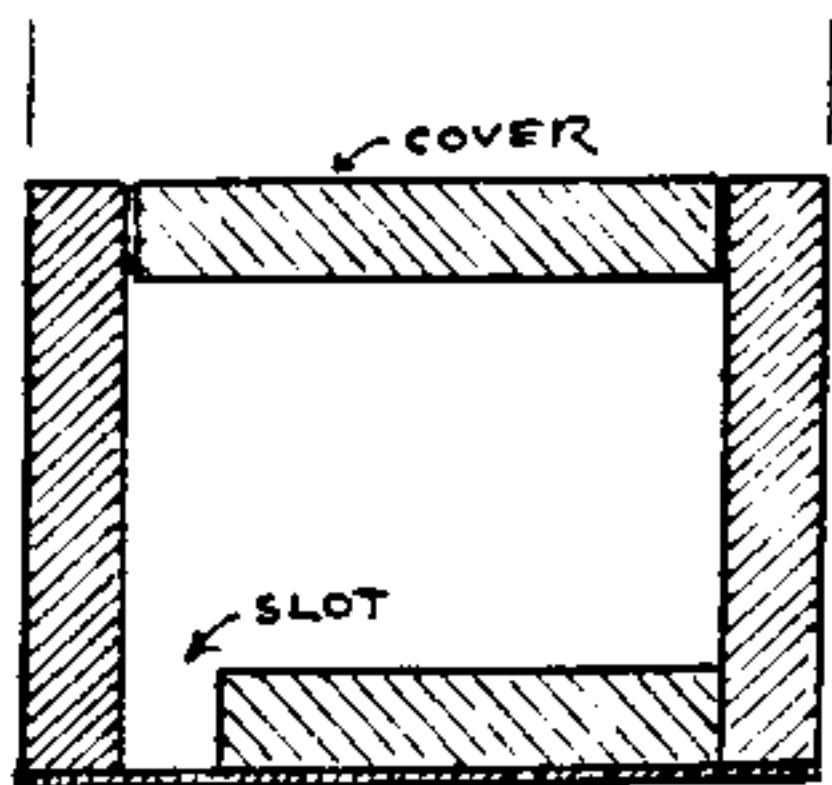

CROSS SECTION

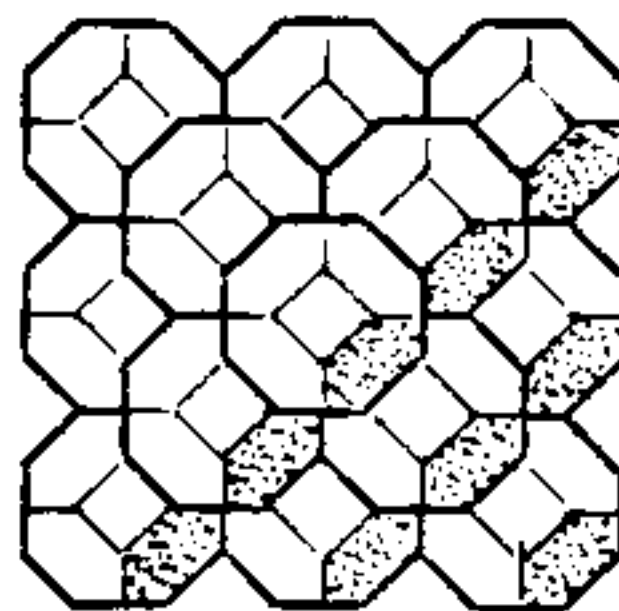

TOP VIEW OF PYRAMIDAL PILE



## Chapter 9 - Puzzles That Make Different Shapes

Puzzles that assemble into more than one shape tend to be more interesting than those with only one solution. Many flat or cubic block puzzles have this feature, but polyhedral puzzles that do it are rare indeed. Here are several in this chapter. The first two are not very difficult to make.

### Triumph Puzzle

This puzzle was mentioned in previous editions, but actual plans for its construction are given here for the first time. If you have successfully made the Four Corners Puzzle, this one should be no more difficult.

Starting with the usual one-inch square stock, using the diagonal saw jig, make six of the six-sided center blocks and six of the five-sided end blocks, as for the Four Corners Puzzle. Call these "right-handed" end blocks. Now make six more five-sided end blocks which are mirror images of these by rotating the stock the other way between cuts. Call these "left-handed" end blocks. Each of the six identically shaped puzzle pieces consists of a six-sided center block, to each end of which is attached an end block - one right-handed and one left-handed. Glue and finish as before. If the pieces are too tight to assemble, the two longitudinal sides of each piece may be sanded uniformly on a belt sander until the proper smooth fit is achieved. The puzzle is assembled in the usual way by mating two halves of three pieces each. Three different symmetrical assembly shapes are possible, as shown on the next page.

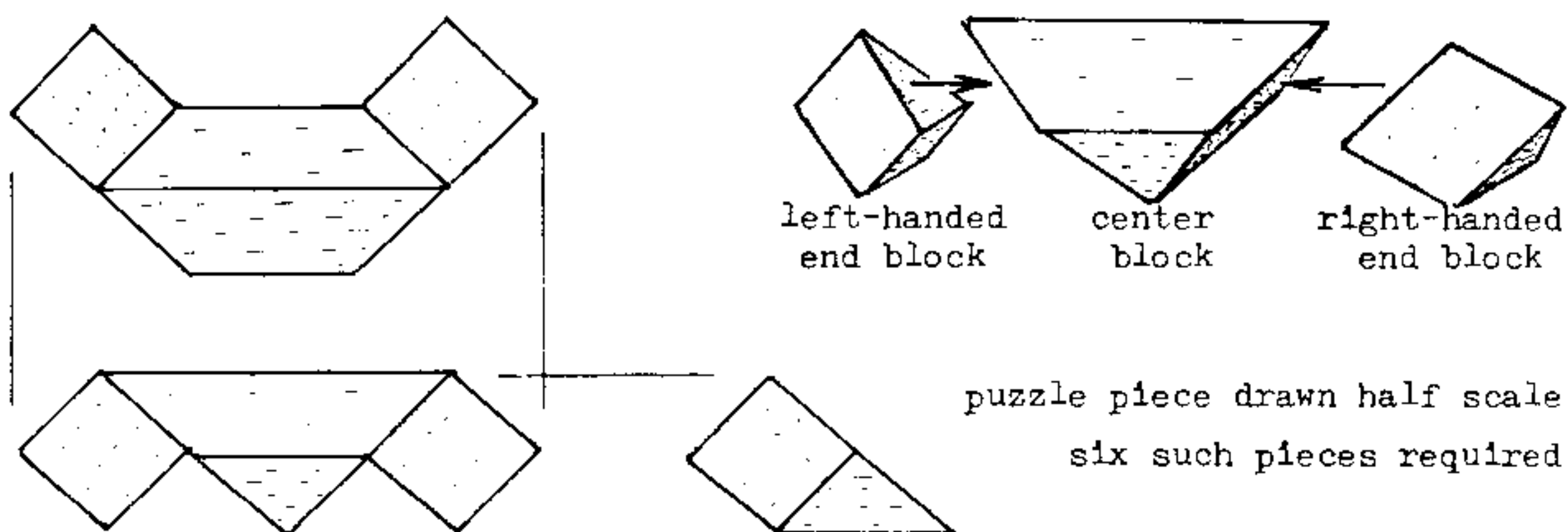

My production version of this puzzle (1974) had the added feature that two dissimilar woods were used in its construction, let us say light and dark, as shown below.



three of each

This allowed each of the three geometrical solutions to be assembled in either of two different color patterns, as shown. The shape on the left could be described as a hexagonal column surrounded by a hexagonal ring - a dark column with a light ring or a light column with a dark ring. The shape in the middle is essentially a Star of David column. The shape on the right is more difficult to describe, and it does not look the same top and bottom. It is also possible to construct other nondescript non-symmetrical shapes.

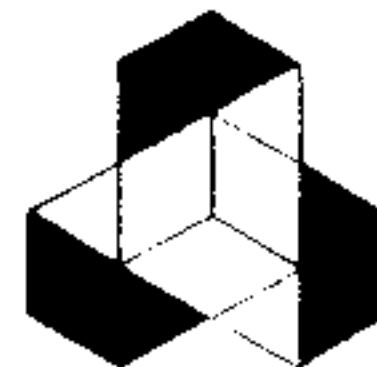
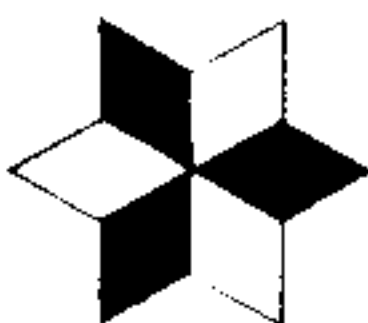
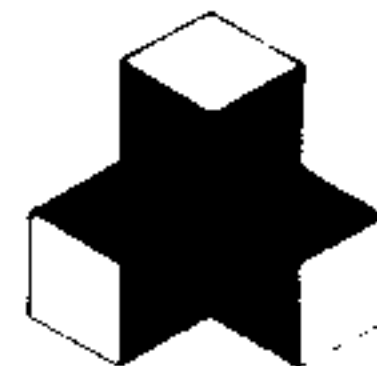
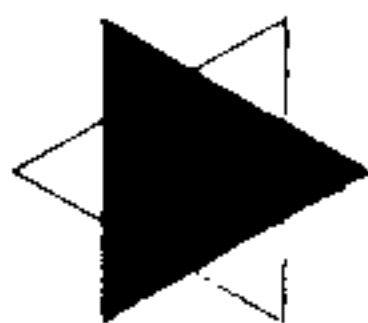
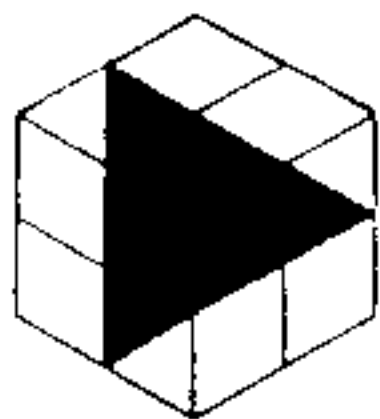
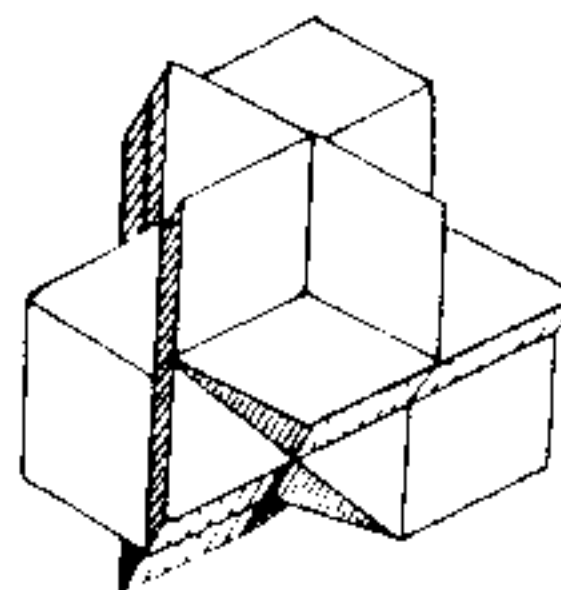
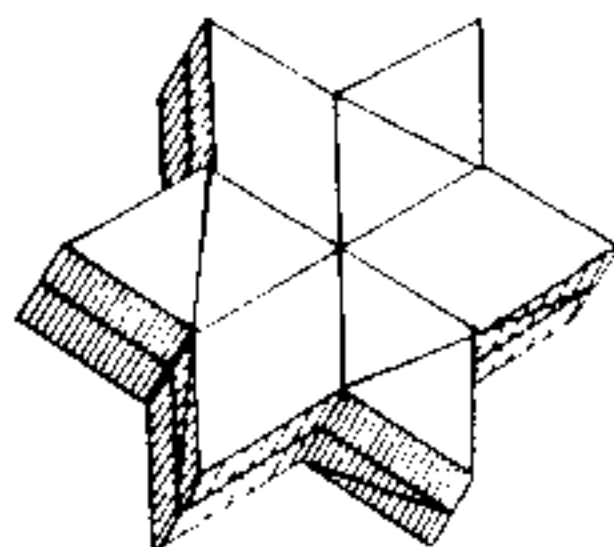
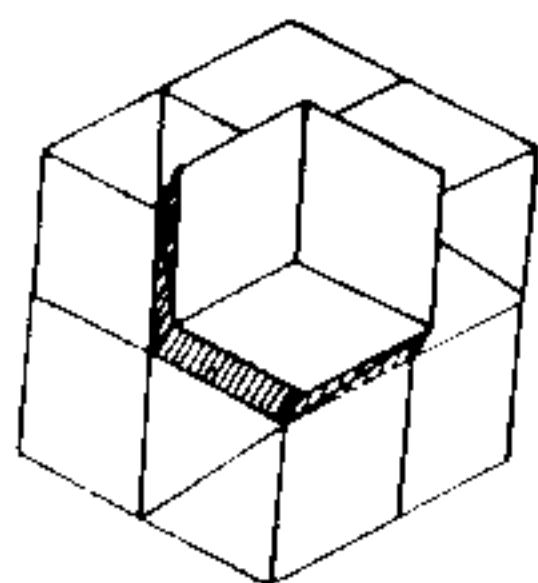

## Fusion-Confusion Puzzle

This recent (1989) puzzle of mine was produced in very limited quantity in 1990. Plans for its construction are here published for the first time. It is a simple yet very confusing puzzle to master, and is among the top favorites of all my puzzle designs. If you have successfully made either the Four Corners Puzzle or the Triumph Puzzle, this one is no more difficult.

Make six identical puzzle pieces following the directions for the Triumph Puzzle, except disregard the two differently colored types of pieces. For this puzzle, all six pieces should be colored identically. Now for the tricky step. With the puzzle assembled in any of its four symmetrical solutions shown below, two pairs of pieces are glued together as shown. To do this, first mark the glue joints with pencil and hold them together with tape in the assembled puzzle until you are sure that you've got it right. Then disassemble, apply glue to the joints, and reassemble the puzzle until the glue sets. If the resulting puzzle is too tight, continue sanding the longitudinal mating surfaces of all the pieces until a smooth fit is obtained for all solutions. Finally, bevel the edges, apply a lacquer finish, wax and buff.

All solutions are made by mating two halves, with each half made up of one simple piece and one fused pair. The COLUMN and STAR each have one unique solution with a confusing diagonal axis of assembly. The left-handed STRANGE has two diagonal solutions. The right-handed STRANGE has one diagonal solution and one axial solution. There are yet other ways of assembly that give rise to any one of four interesting but nondescript shapes with no symmetry.

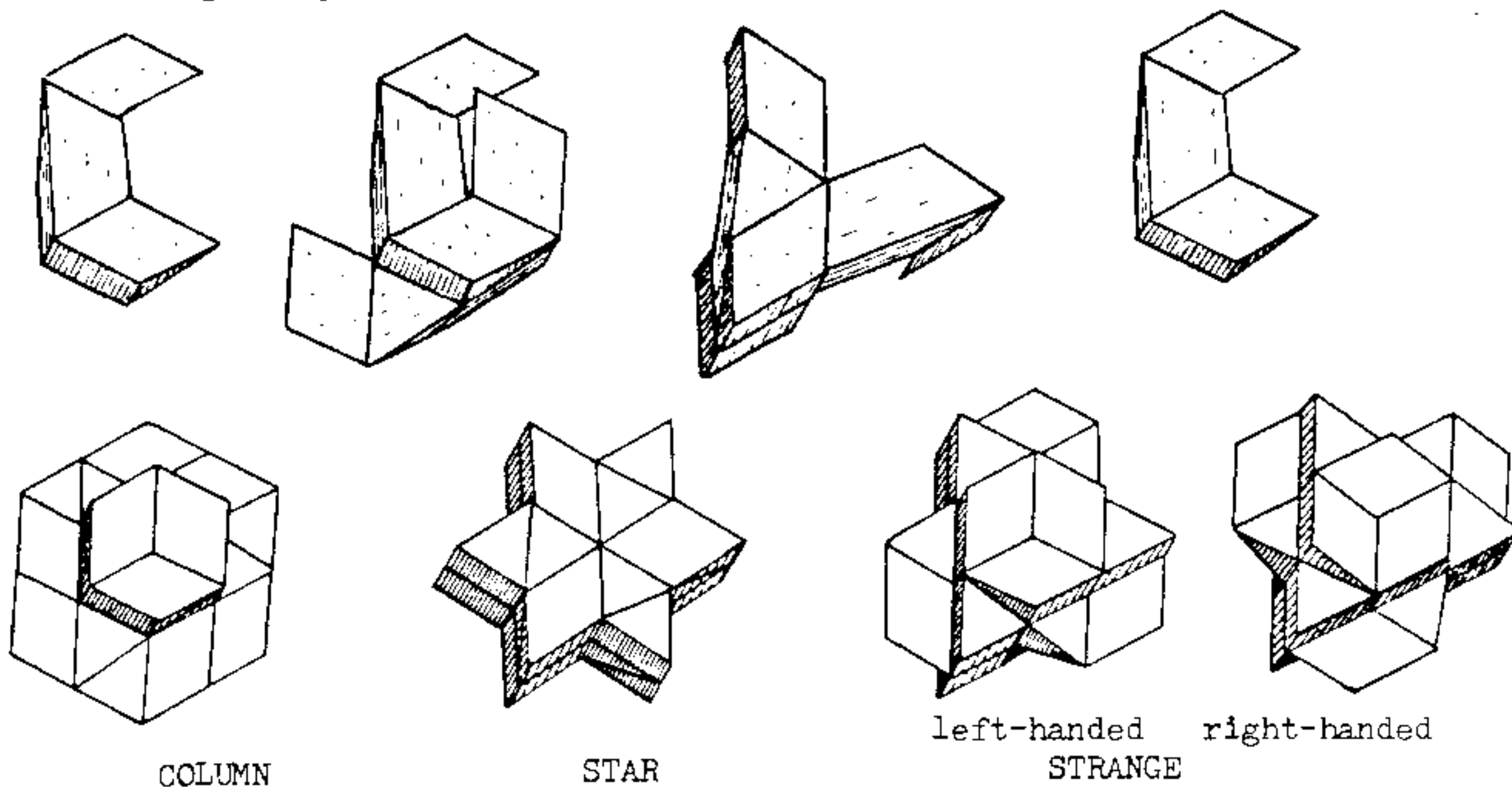

Note for the advanced woodworker: My production versions of both the Triumph Puzzle and Fusion-Confusion Puzzle used colorful combinations of exotic woods sawn and arranged such that symmetrical patterns of end grain appeared in all solutions. This was done without waste by making two puzzles at one time and paying careful attention to the direction of growth ring patterns.

### Star of David Puzzle

This unusual puzzle was first produced in 1981 for limited distribution to "Puzzle Club" members, and it quickly became one of my most popular designs. Plans for its construction, probably hopelessly inadequate, were published in the 1985 *Puzzle Craft*. Brief but somewhat more explicit plans are in *Puzzling World*. In the meantime I have discovered a much improved version, here published for the first time. Also published here for the first time are the complete solutions. This is not an easy puzzle to make, because the complicated shaped pieces must be very accurately crafted in order to fit together smoothly and easily all different ways. When accurately made, it is a delightful puzzle to play with.

The six puzzle pieces are shown below. Note two pairs of identical pieces. The letters refer to building blocks already described. This puzzle has the unusual property that its six interlocking pieces can be assembled into four different symmetrical shapes. Three of these intriguing polyhedral solids have a threefold axis of symmetry and are shown on the next page. The fourth shape, not shown, has bilateral symmetry plus a twofold axis. The STAR and SQUAT have only one solution each, with a confusing diagonal axis of assembly. The SPIRAL has one diagonal and one axial solution. The BILATERAL shape has six solutions. There are also many ways the pieces go together to form interesting but nondescript shapes.

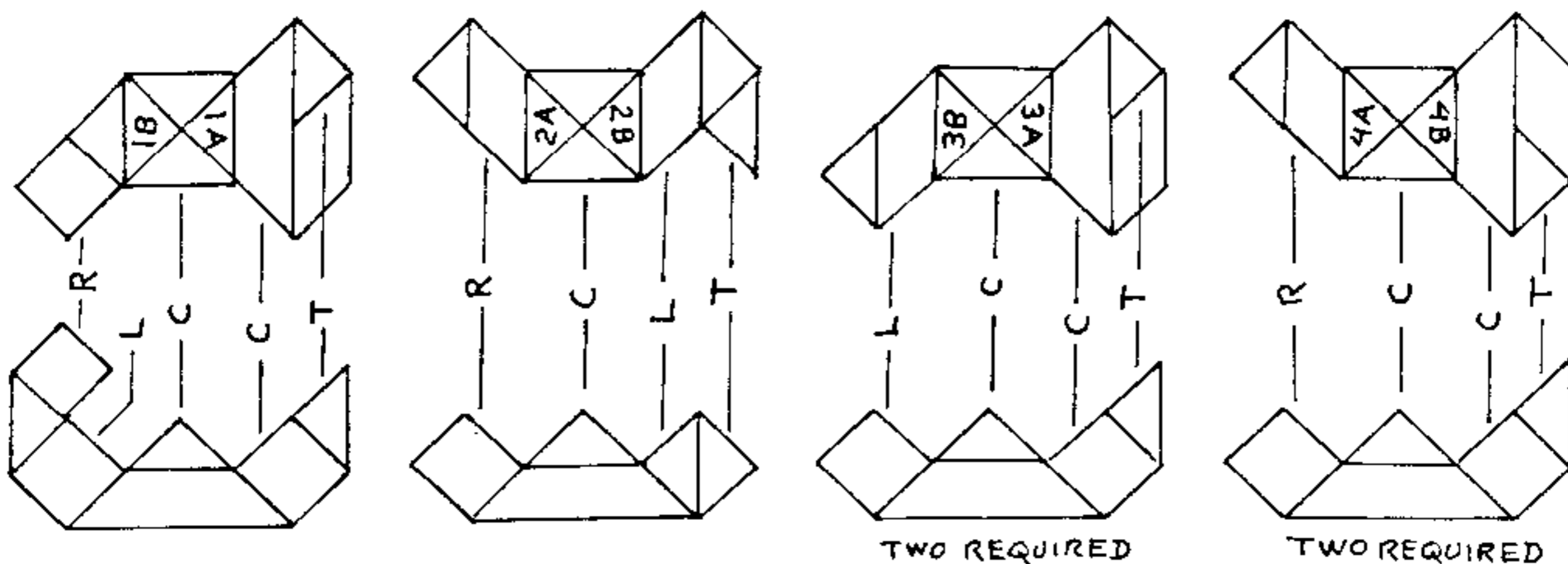

- C - SIX-SIDED CENTER BLOCK
- L - LEFT-HANDED 5-SIDED END BLOCK
- R - RIGHT-HANDED 5-SIDED END BLOCK
- T - TETRAHEDRAL BLOCK

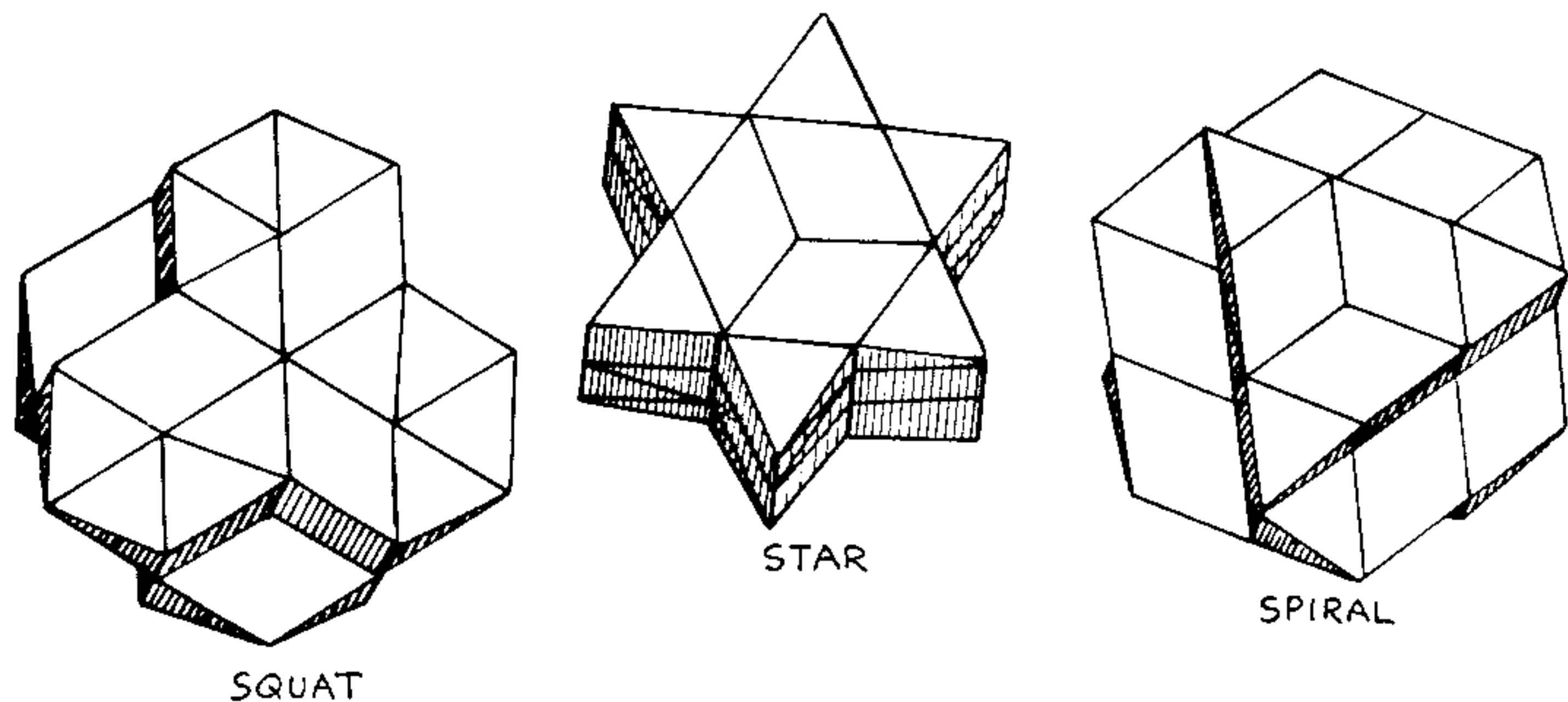

The four types of puzzle pieces are numbered, and the two ends distinguished by letters A and B, in order to show the solutions below. After making the two halves of three pieces each, some trial and error may be required to get them mated with the correct orientation. As the two halves mesh together, it is quite a surprise when the symmetry of the solution suddenly pops out before your eyes!

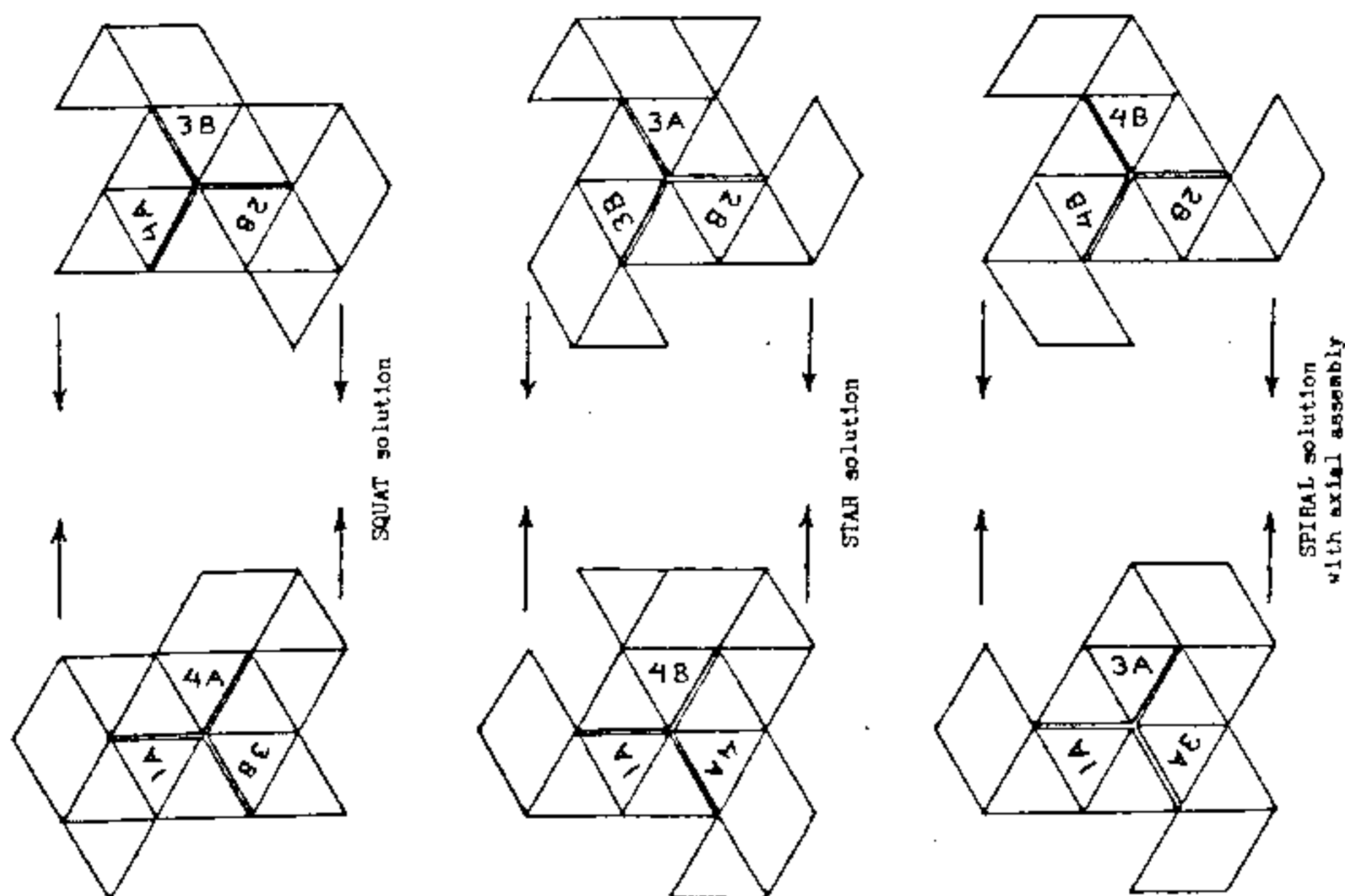

## Chapter 10 - Pennyhedron and Garnet Puzzle Families

### Pennyhedron Puzzle

When our kids were small, they used to spend hours in my shop patiently gluing together little scraps of fancy wood to make "puzzles" for their friends. One time we had a lot of scrap blocks in the shape of rhombic pyramids which they industriously glued together all different ways. What emerged from this was the simple two-piece puzzle shown below. It has two mirror-image halves of six blocks each that fit together with no difficulty. It is when you try to take it apart that the fun begins, because if carefully made, the planes of separation are not obvious. Most persons will grasp randomly with thumb and forefinger of both hands and pull. But it will never come apart that way because you will always be holding both halves in each hand. Only with an unnatural three-finger grasp does it come apart with ease.

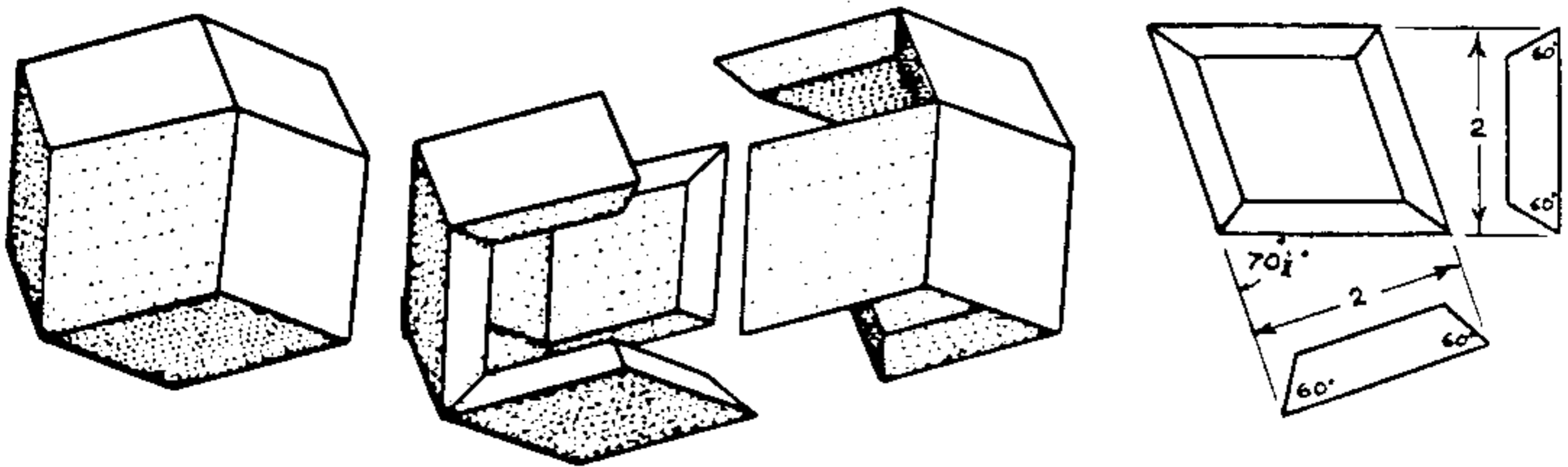

Despite the unusual geometry, this puzzle is fairly easy to make. You can use a good grade of hardwood plywood or plain lumber, and of any thickness you choose. With 1/4-inch plywood, the glue joints will not be very strong. These drawings assume use of 1/2-inch plywood. With the table saw tilted to 60 degrees, saw out a strip a few feet long having the trapezoidal cross-section shown. With the miter angle set at 70.5 degrees, make two 60-degree cross-cuts to make a rhombic shaped block. Check the dimensions carefully. When you have 12 identical blocks, assemble them into the polyhedral shape shown (a rhombic dodecahedron), using tape and rubber bands to secure them tightly and accurately together. Then start selectively gluing the joints. If accurately made, the two halves should slide together with a smooth friction fit three different ways. One accurately made set, lacquered and well waxed, serves as a gluing jig for making others. By the way, the kids used to put a penny inside, hence the name.

Slightly different directions for making the Pennyhedron Puzzle may be found in the Nov. 1984 (#49) issue of *Fine Woodworking* magazine.

## Pennydoodle Puzzle

This next puzzle is considerably more complicated to make but a lot of fun to play with if well made. Start by making four identical Pennyhedron Puzzles. Then join six of the halves in pairs to make the set of three whole puzzle pieces and two half pieces shown below.

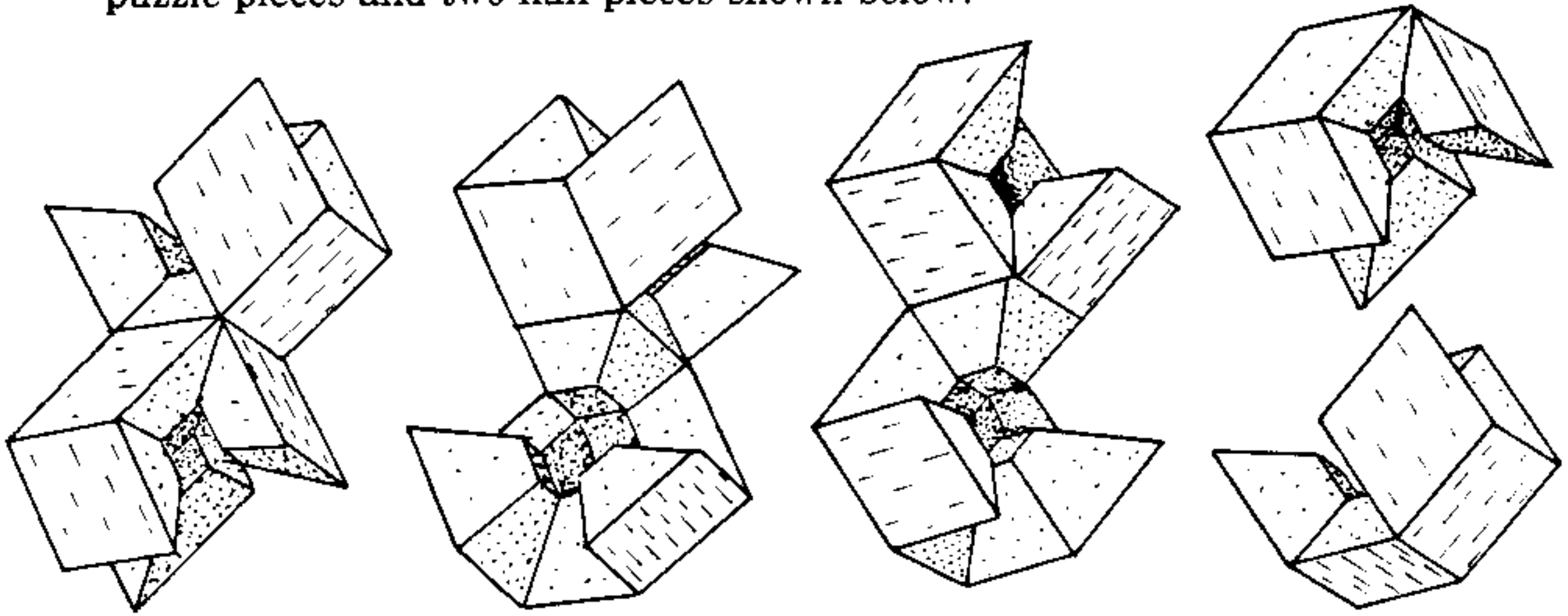

These Pennydoodle puzzle pieces will form all of the shapes shown below. See how many you can do.

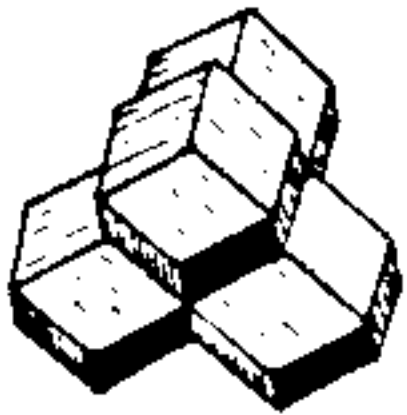

Tetrahedron  
1 solution

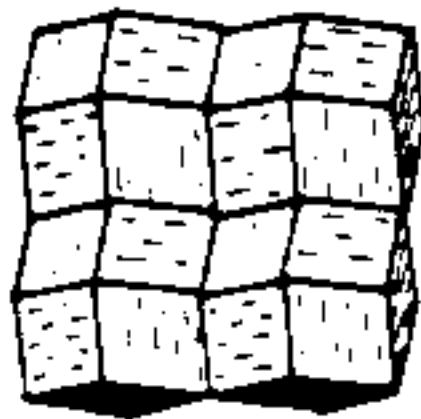

Square  
1 solution

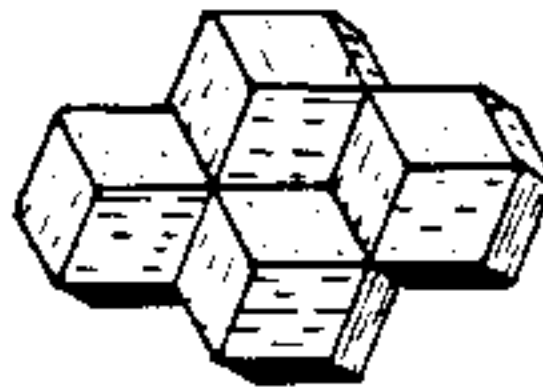

Diamond  
6 solutions



Straight  
3 solutions

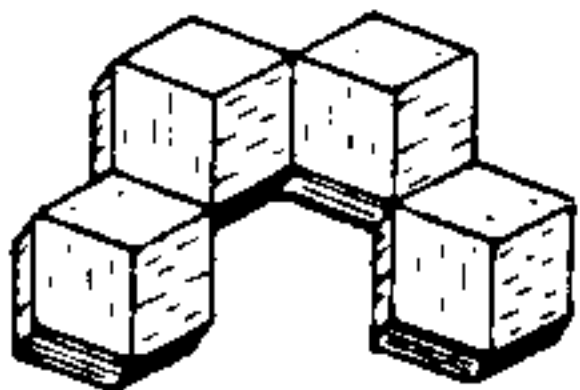

Arch  
5 solutions

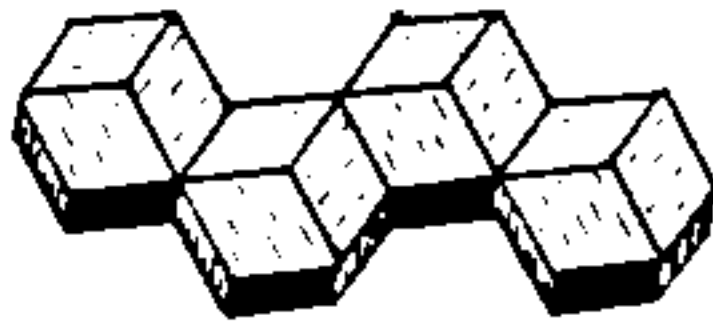

Snake  
6 solutions

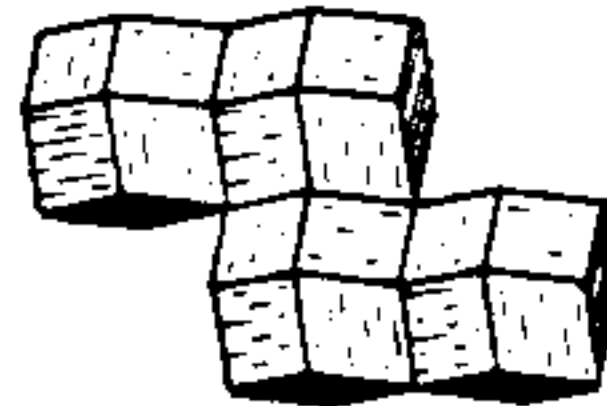

Zig-zag  
2 solutions

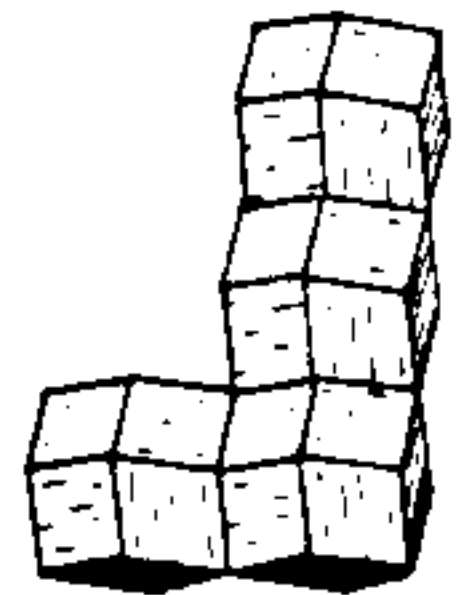

Angle  
6 solutions

For further recreations with these fascinating pieces, note that you need not follow my plans. There are 17 other ways of joining pairs. Make up your own set and see what constructions are possible. Make a double set of my pieces to play with.

## Fourth Dimension Puzzle

This puzzle resembles the Pennydoodle Puzzle in appearance but is altogether different as a puzzle, having a pair of solutions that are surprising, baffling, and very unusual. It would be no harder to make except that accuracy and stability are required to bring out its full potential. This is a quite recent discovery, published here for the first time and never produced for sale.

Start by making four Pennyhedrons, slightly loose fitting, and join them as shown below, as accurately as possible, to make two identical pairs of puzzle pieces.

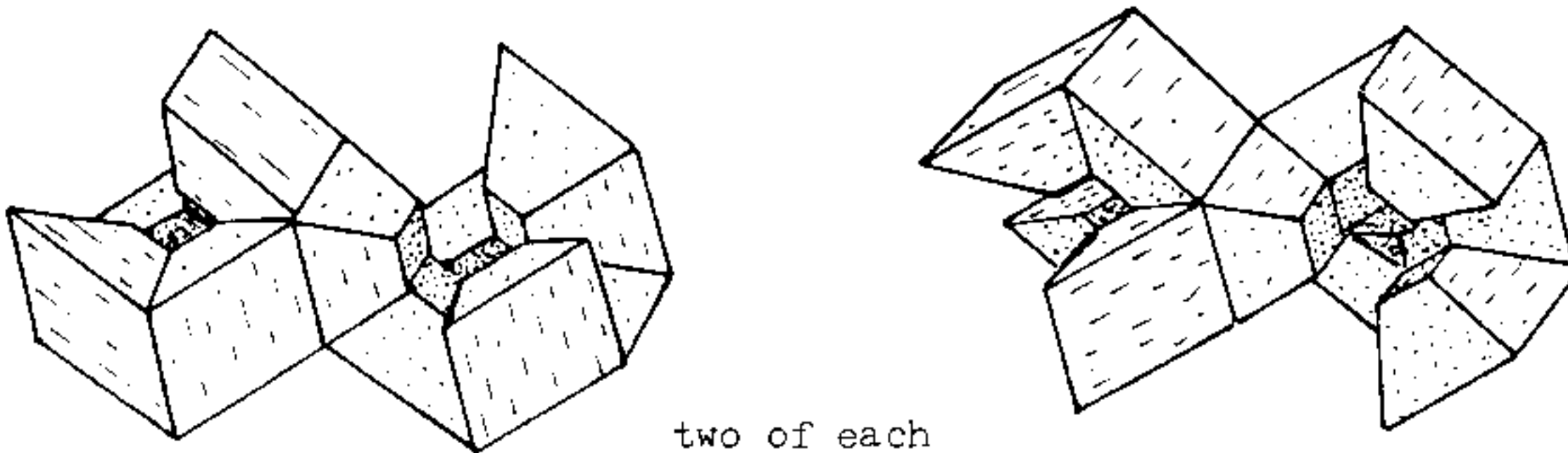

These four pieces can be assembled to construct either a tetrahedral pile or a square assembly, as shown below. Neither of these can be assembled in the usual manner. They both require the simultaneous manipulation of all four pieces to assemble. This is quite entertaining. It is the only such dual puzzle I know of with this property. (See the chapter on Coordinate Motion Puzzles in my Oxford book ) The mating surfaces should be finished smooth, lacquered and well waxed.

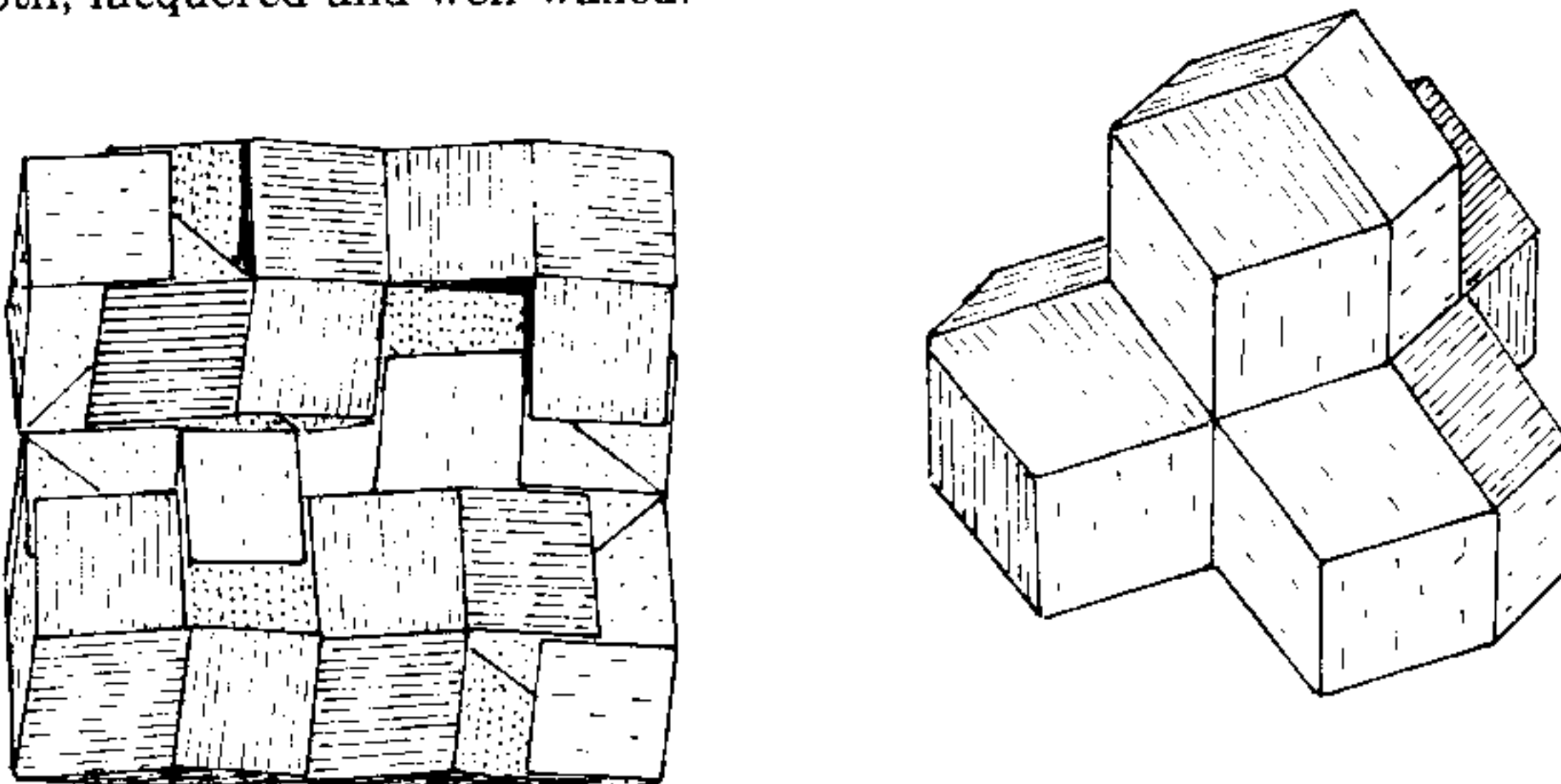

Square assembly shown partially disassembled



## Garnet Puzzle

If you have successfully made the Pennyhedron Puzzle, this one is no more difficult to make. It is an interesting puzzle, and quite attractive in fine woods.

Start by making about 4 linear feet of stock with uniform 30-60-90-degree triangular cross-section. The full scale drawing below is a suggested size, but you can easily scale it up or down to any size you wish. With the miter again set at 70.5 degrees and the saw tilted 30 degrees, a diagonal cut is made on the end of the stick. With the saw then tilted 30 degrees the other way, the stick is advanced such that the second cut just meets the first cut at the top, producing a pyramidal point. You will need a mechanical stop for this in order to make 24 identical blocks.

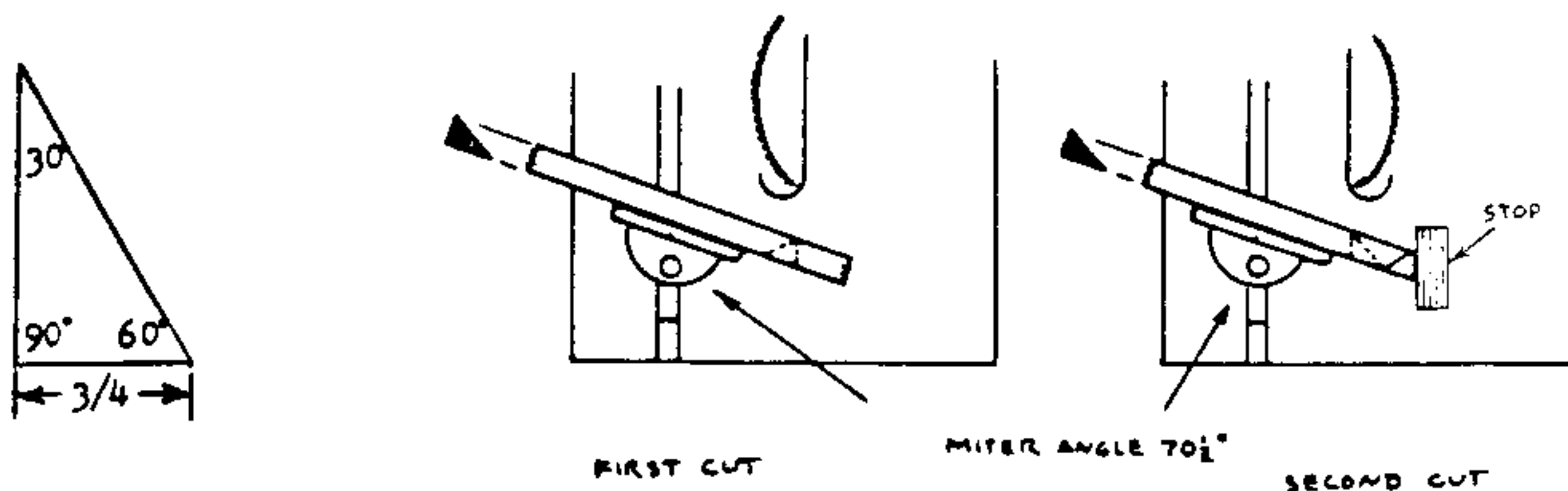

Once you have this set up accurately, there is an alternate way of making the blocks using stock with trapezoidal cross-section. This simply eliminates the pyramidal point, saves lumber, and makes the center of the puzzle hollow.

Assemble the 24 blocks into the shape of a solid rhombic dodecahedron, held tightly together with tape and rubber bands, and check the accuracy of fit. When it looks right, start selectively gluing the blocks together to form the six dissimilar puzzle pieces, shown below.

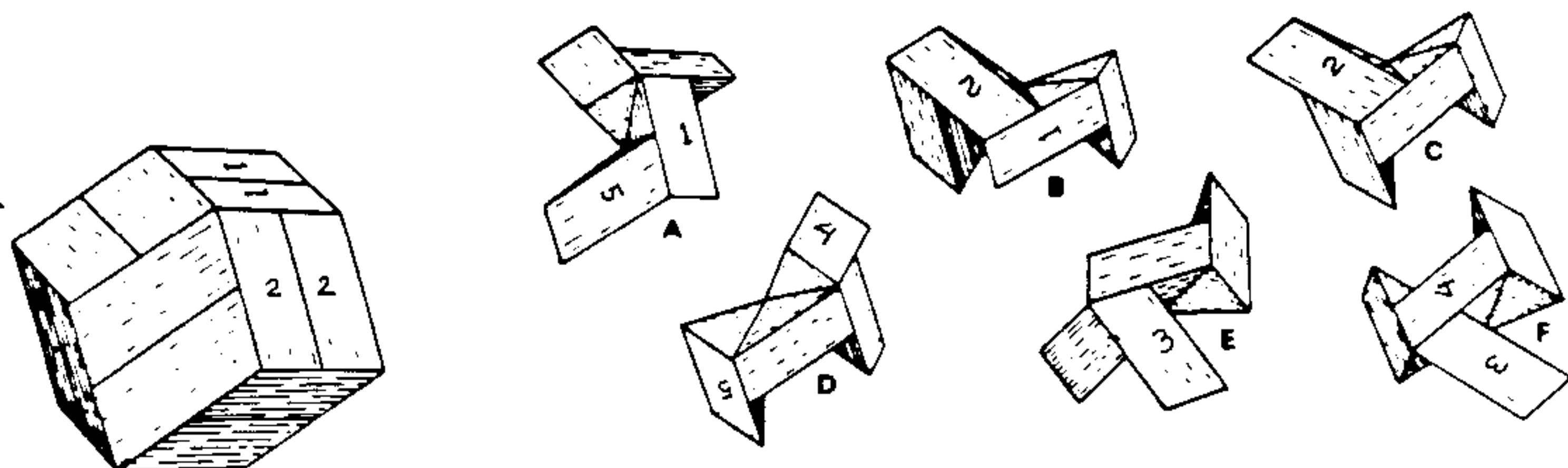

To identify the pieces and their respective positions, you will need to study the drawings carefully and mark the pieces. The solution to the puzzle is found by matching the numbers. The puzzle is assembled by first forming two halves of three pieces each: A-B-C and D-E-F, and then mating the two halves.

Since the shape of the assembled puzzle is entirely convex, the 12 faces can be machine sanded and polished to a fine finish. An especially beautiful effect is obtained by using six contrasting fancy woods for the six pieces, as was done with the model shown on the cover, which uses sumac, satinwood, ebony, walnut, peroba rosa, and breadnut. The pairs of light, dark, and reddish woods are all arranged opposite each other for maximum contrast and balance.

Note also that the puzzle is essentially solid in geometrical construction. Thus, the assembled puzzle can be sawn or sanded down to make various beautiful sculptural shapes, three of which are shown below.

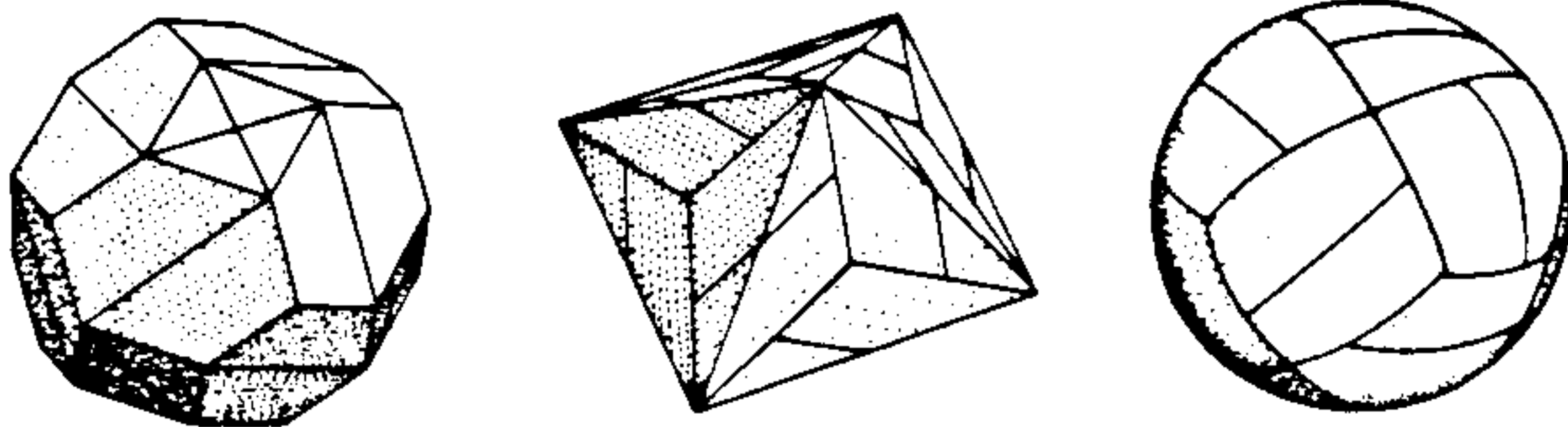

### Thirty-Sided Puzzle

There is a more complicated variation on the Garnet Puzzle theme, having 30 faces rather than 12 and made up of 60 blocks rather than 24. One is shown on the cover, top-center, identified as Design No. 72. The significance of the term "design" is that no satisfactory puzzle was invented for this geometrical solid. For the benefit of those who may wish to tinker with this idea, or simply make a very attractive wooden sculpture, the same procedure is followed as for the Garnet Puzzle in sawing out the blocks, only all the angles are different. See the drawings below. Assemble and glue as before.

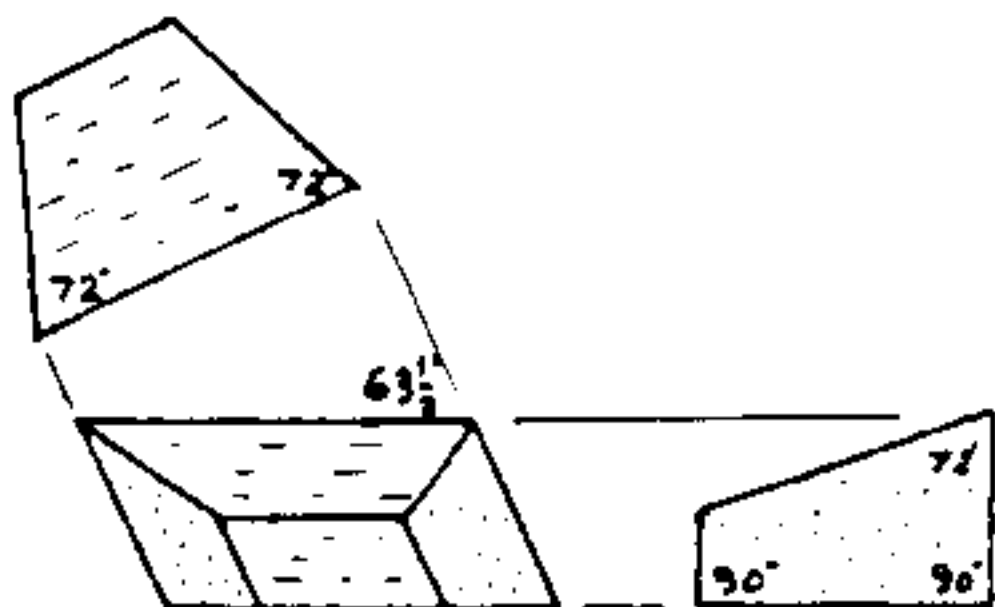

truncated blocks sawn from trapezoidal sticks

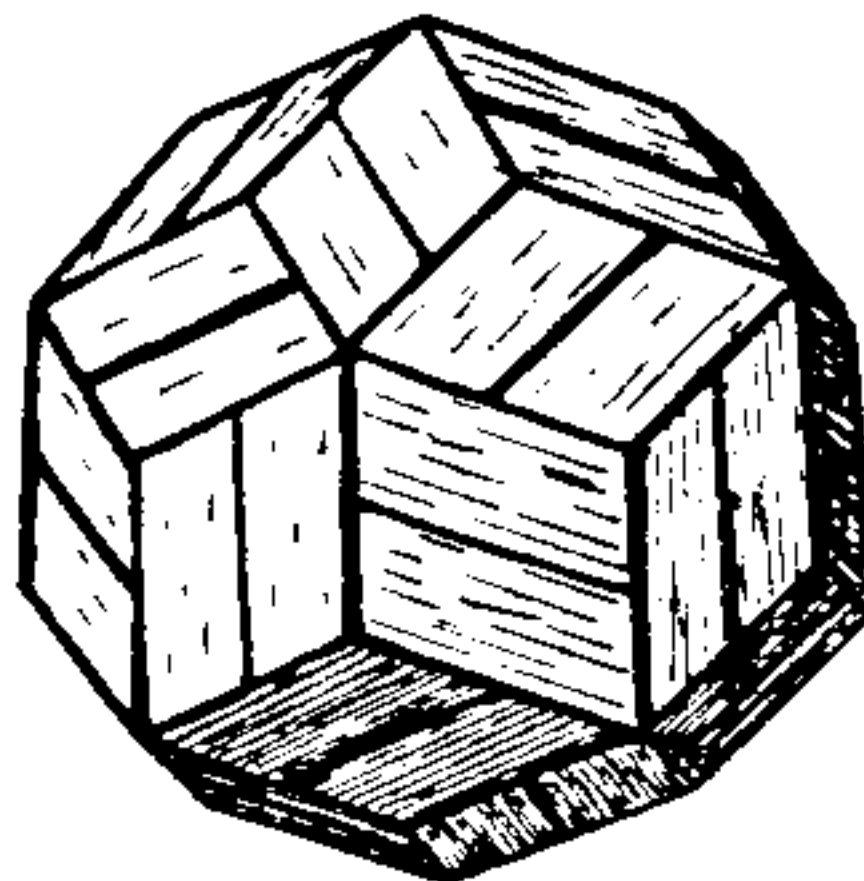

## Chapter 11 - Square Prism Puzzles

### Square Prism Puzzle

This simple puzzle, with its six identical pieces, is not very difficult to make. As an assembly puzzle, it belongs in the same family as those of Chapter 7. In other words, it assembles easily by mating two halves of three pieces each, making it more of a sculptural novelty than an assembly puzzle. It is quite attractive when well made of fine wood. For best results, the two halves should slide together smoothly and easily, yet snugly, so some patience may be required to get the angles and fit just right. A stable wood should be used to allow for changes in humidity. This puzzle is a good practice exercise for the most intriguing Three Pairs Puzzle immediately following.

Start with stock of accurate right-triangular cross-section as shown. Cross-cut into six pieces 3.75 inches long. Make a trapezoidal notch in each piece. Sand the pieces if necessary to obtain a smooth fit. Break or bevel the sharp edges, and finish.

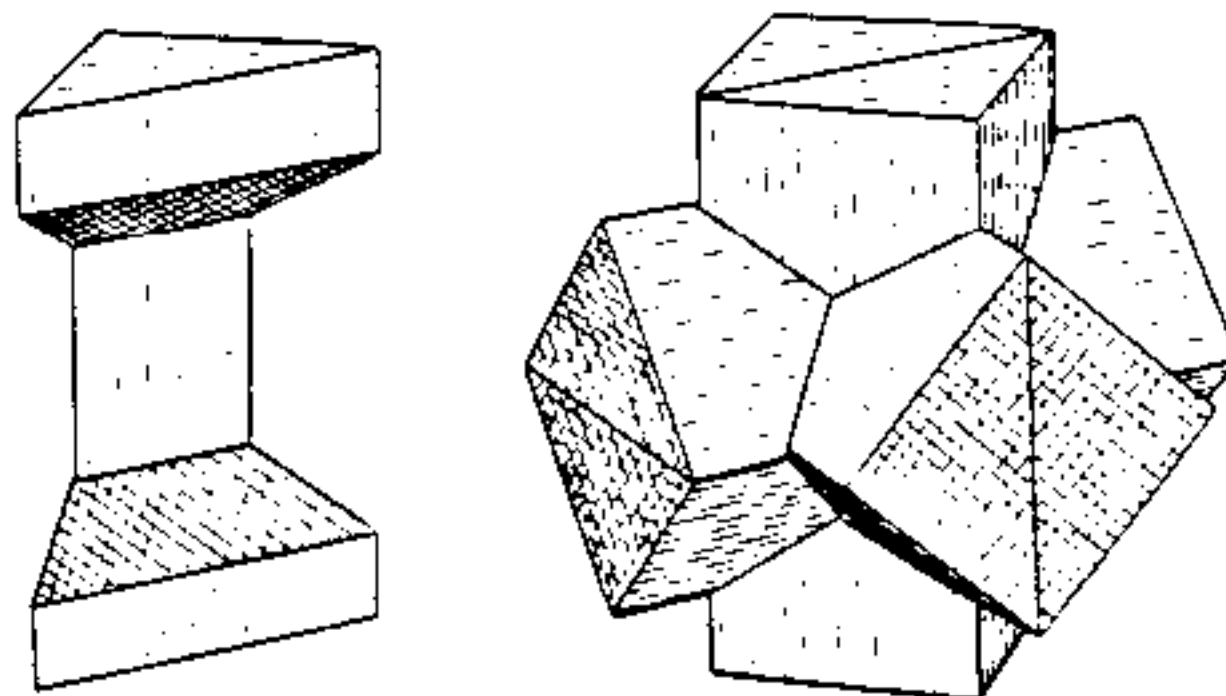
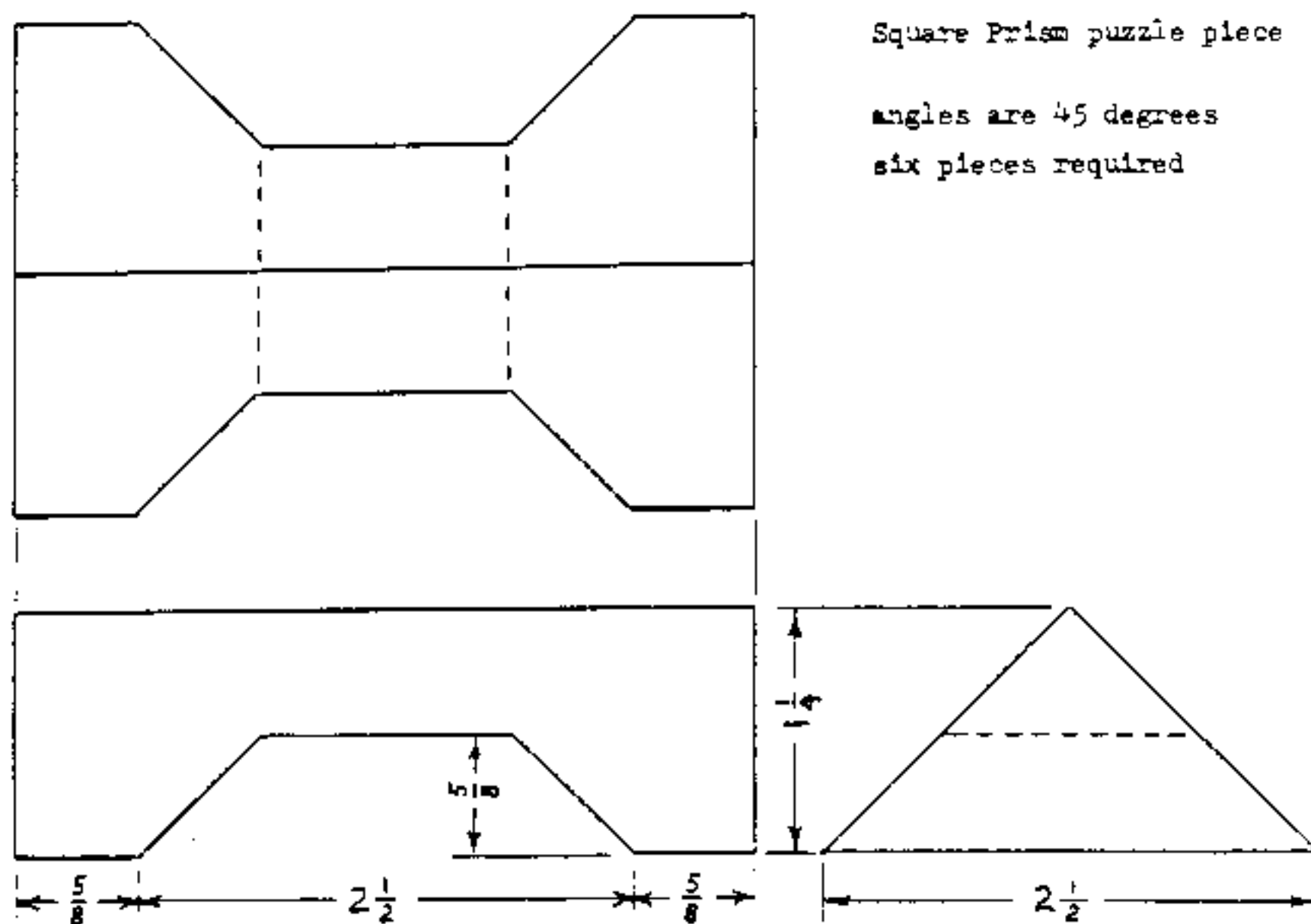

## Three Pairs Puzzle

I came up with this design in 1973. I made and sold them for several years thereafter, mostly in Honduras mahogany but some in Brazilian rosewood. Some were sent to puzzle experts disassembled and without directions. It seems amazing that such a simple puzzle, with its six nearly identical pieces, could be so baffling.

The solution to the puzzle is here published for the first time: The puzzle is assembled by first making up two halves of three pieces each and then mating the two halves, exactly like the preceding Square Prism Puzzle. The tricky part is in forming the two halves. Each half is made up of three identical puzzle pieces, and they must be manipulated in unison to be assembled. The easiest way to learn this is to first assemble them with tape, before gluing, and see how they slide apart.

To make the 12 identical half-pieces, refer to the drawings below and to the techniques used for the Square Prism Puzzle. To check the fit, tape them together in pairs and assemble as with the Square Prism Puzzle. Then glue them in pairs as shown. For best accuracy, the puzzle should be assembled while the glue is setting.

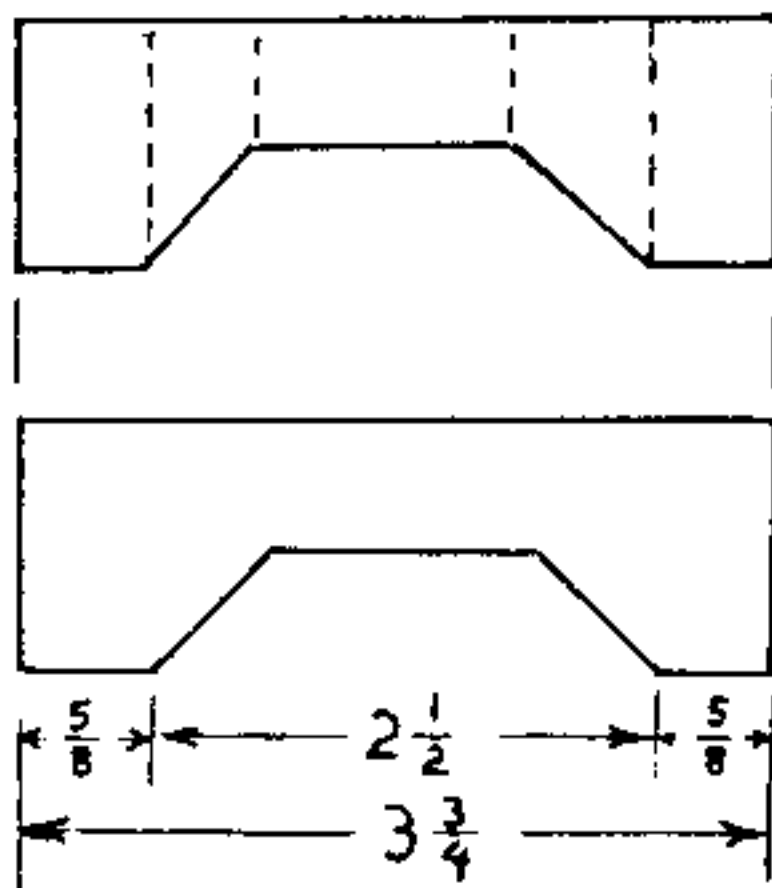

half-piece  
drawn half-scale  
twelve required  
angles 45 degrees

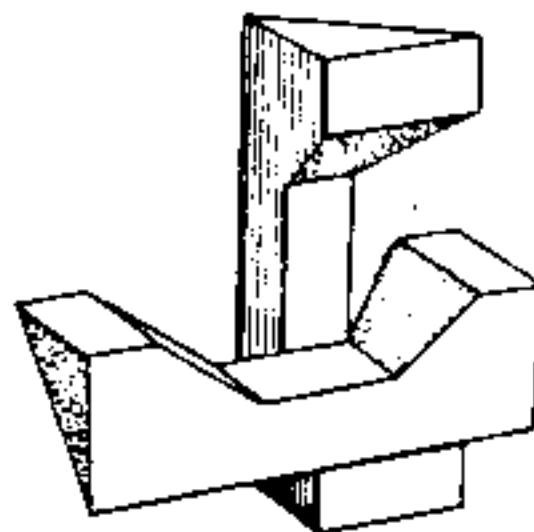
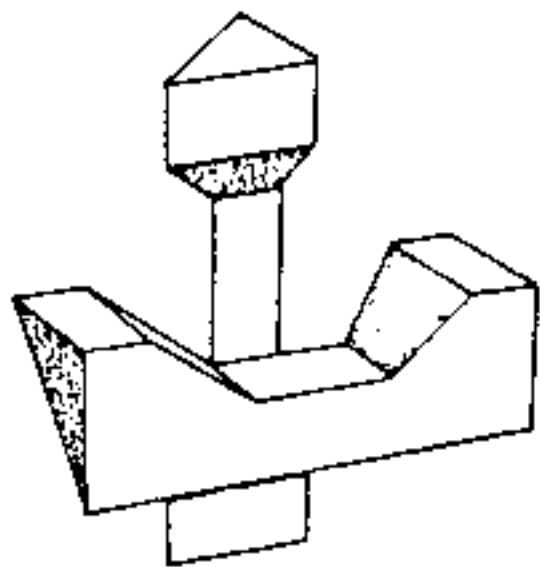
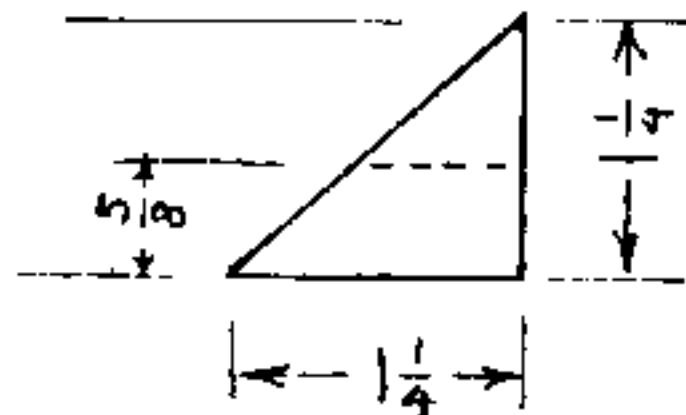

puzzle pieces  
three of each required

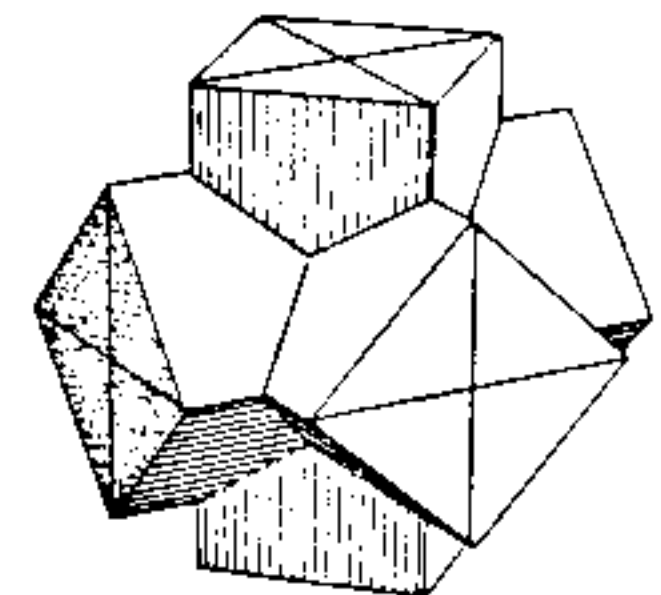

assembled puzzle

## Chapter 12 - Triangular Twelve-Piece Burr

### Twelve-Piece Separation Puzzle

In terms of geometrical complexity and number of pieces, this is probably the most complicated puzzle in this book. It is also probably the most difficult to solve, and step-by-step directions are given. Yet it is not terribly difficult to make, especially for those who have gone this far in the book. It is one of my top favorite designs, and I strongly recommend it for the advanced woodworker and puzzle devotee. I came up with this puzzle in 1990, and it is here published for the first time.

Start with about 8 feet of accurate, uniform equilateral triangular stock, easily made by ripping unwarped lumber with the saw set at 60 degrees. All of the cross-cuts for making both the 12 triangular sticks and 24 pyramidal end blocks are made with the miter set at the same 55 degrees. The ten "standard" pieces and one "augmented" piece have blocks glued on at both ends. The "key" piece has a block at one end only. The extra block gets attached to the "augmented" piece after assembly. Some experimenting and sanding may be required to get just the right fit, assemblable yet not too loose.

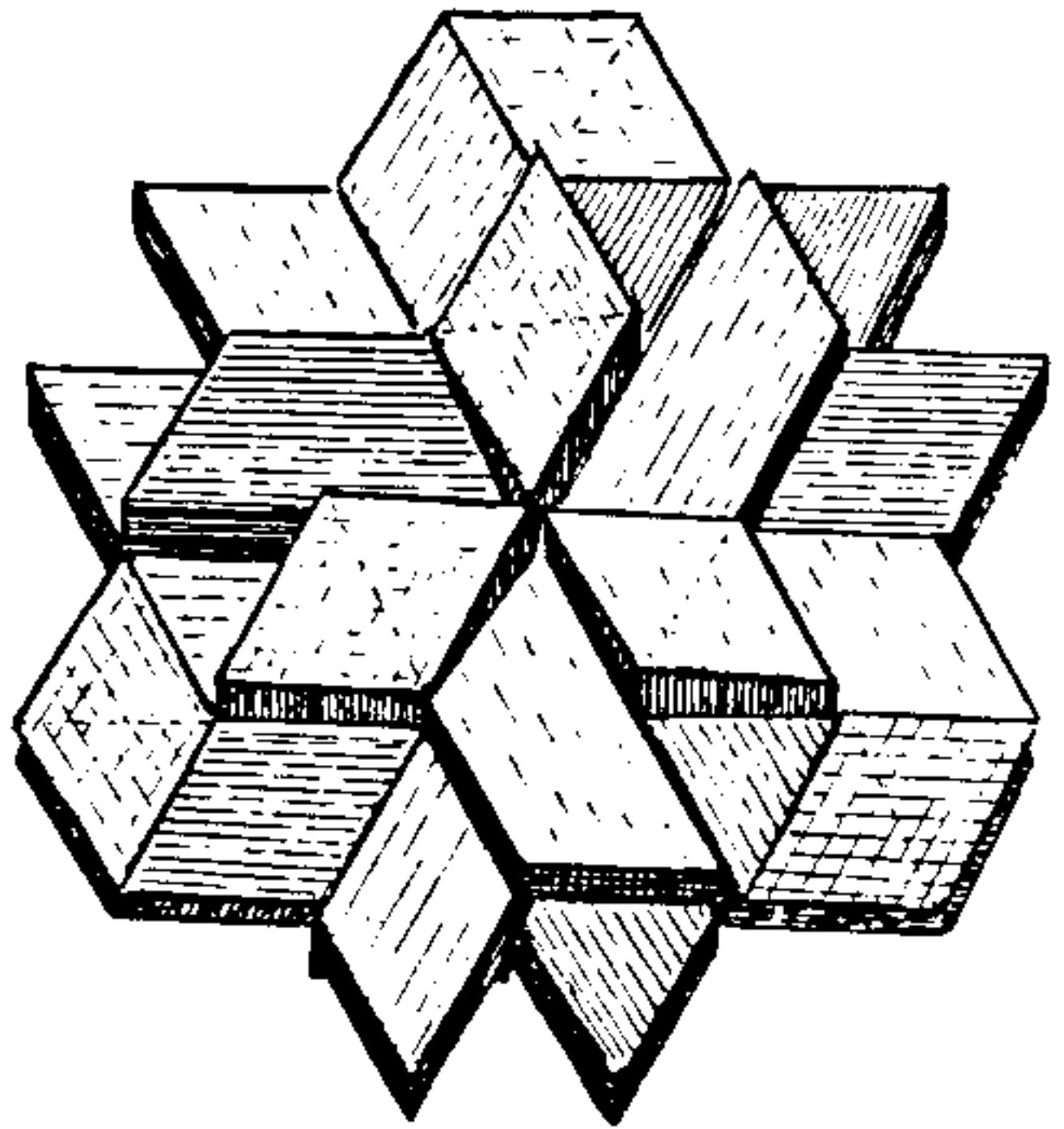
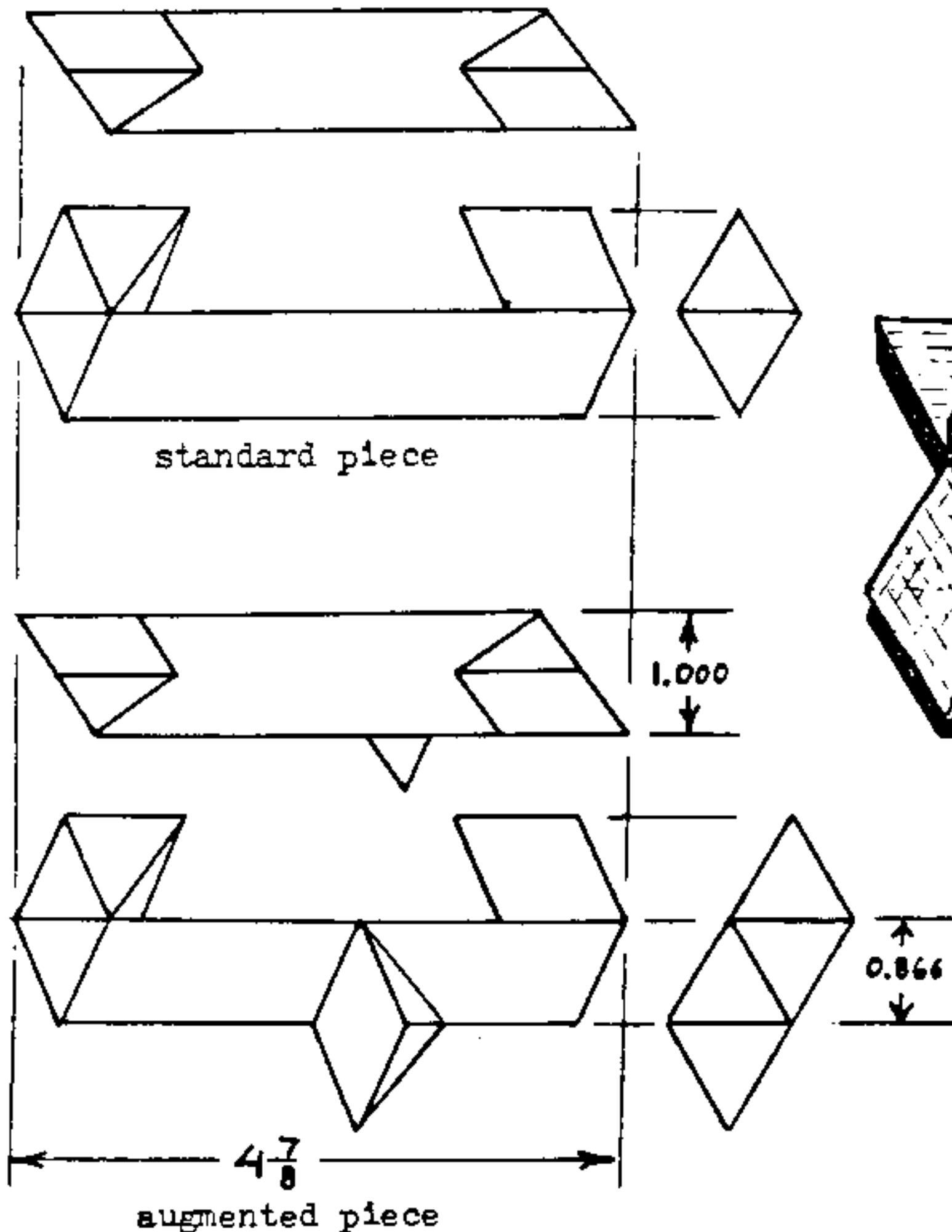

See woodworking section in Appendix for special saw jig

# Assembly directions for the Twelve-Piece Separation Puzzle

Pieces are here numbered in order of assembly. All figures are looking straight down from above.

1. Assemble three pieces as shown in Fig. 1 to form a triangular base.

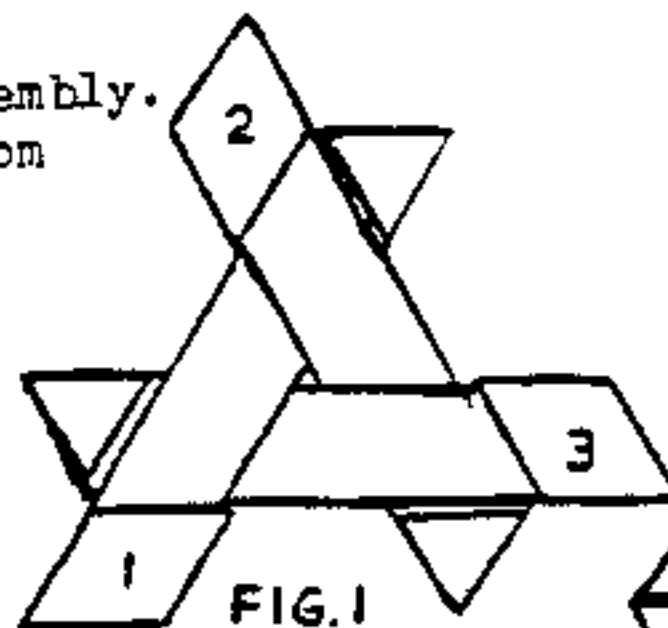

2. Insert piece 4 vertically, hook augmented piece 5 around it, and then insert piece 6 vertically from below, as shown in Fig. 2

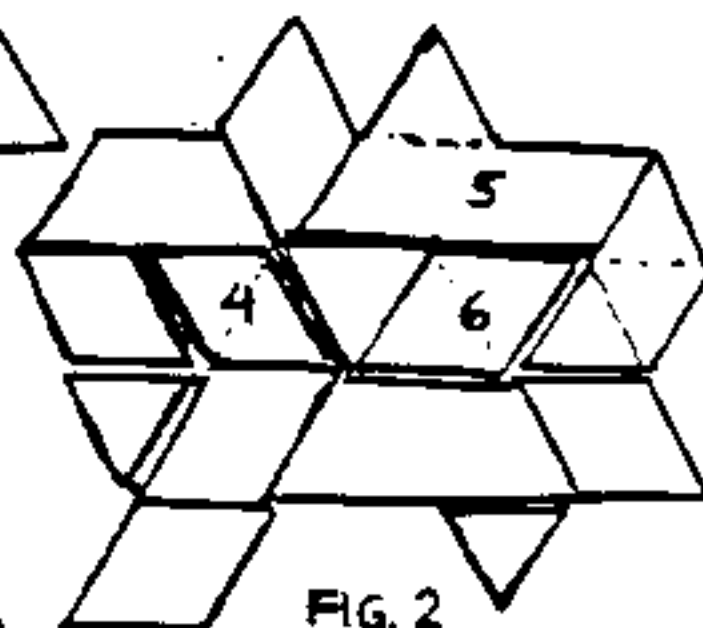

3. Push piece 1 inward all the way and piece 3 one inch to the right in order to insert piece 7, as shown in Fig. 3. Return piece 3 and then piece 1 to their previous locations.

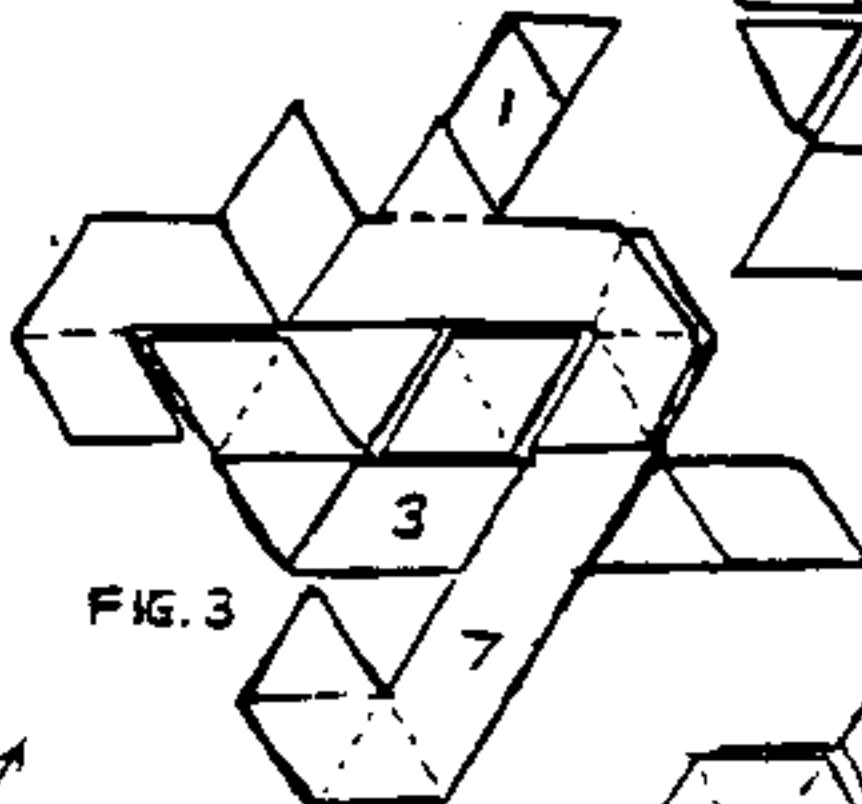

4. Install piece 8 from the left, as shown in Fig. 4. These first four steps will require some dexterity and patience to hold all the pieces in place, but from here on it gets easier.

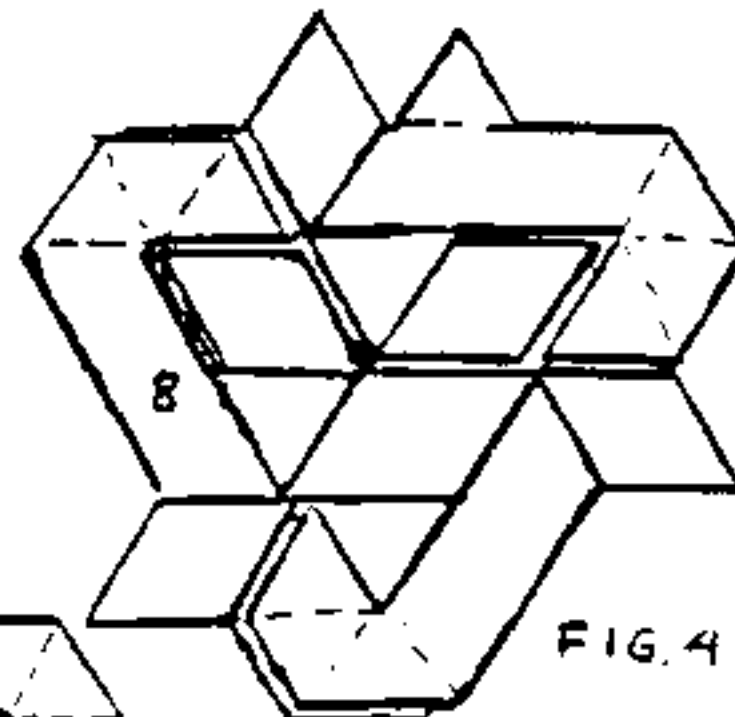

5. Drop piece 4 down, push piece 7 in, and slide piece 8 one inch to the right in order to install piece 9 vertically. With piece 9 dropped all the way down, return piece 7, then piece 8, and raise all vertical pieces into position, as shown in Fig. 5.

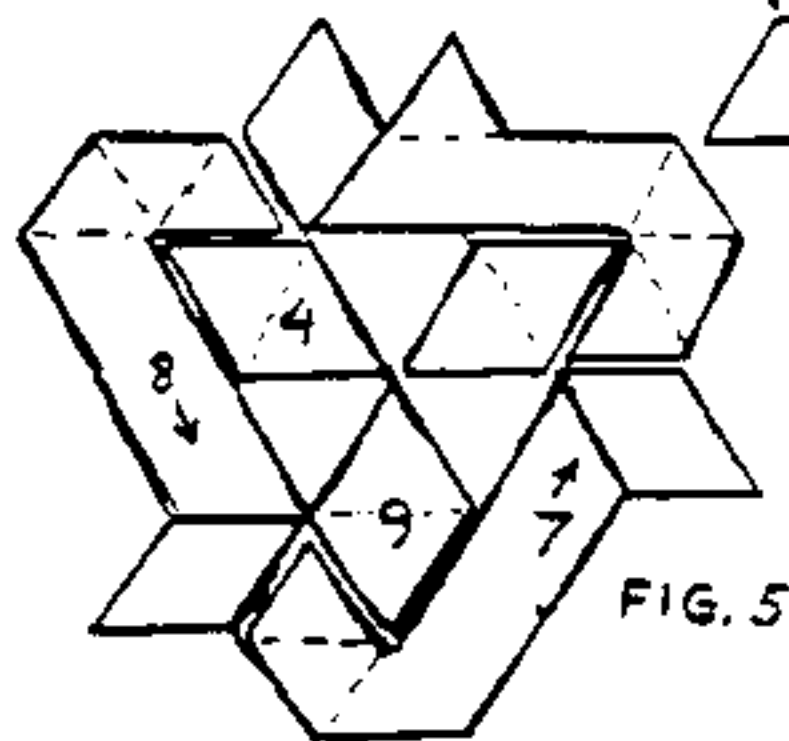

6. Piece 10 is directly installed from the left, as shown in Fig. 6.

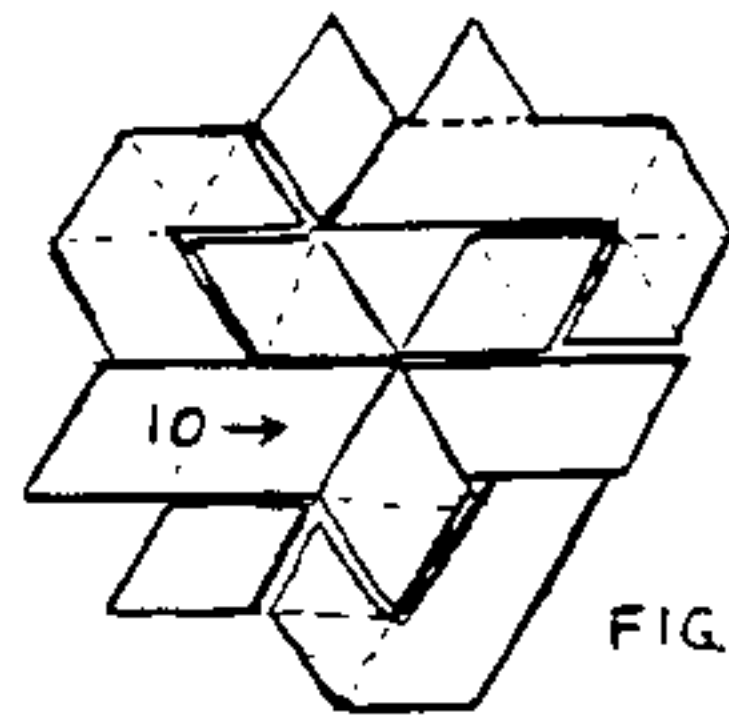

7. Now the tricky step. Drop pieces 4 and 6 down, slide piece 8 far to the lower right, then piece 10 one inch to the right in order to insert piece 11, as shown in Fig. 7. Return piece 10 left, raise piece 6, slide piece 11 into place, return piece 8, and raise piece 4 into place.

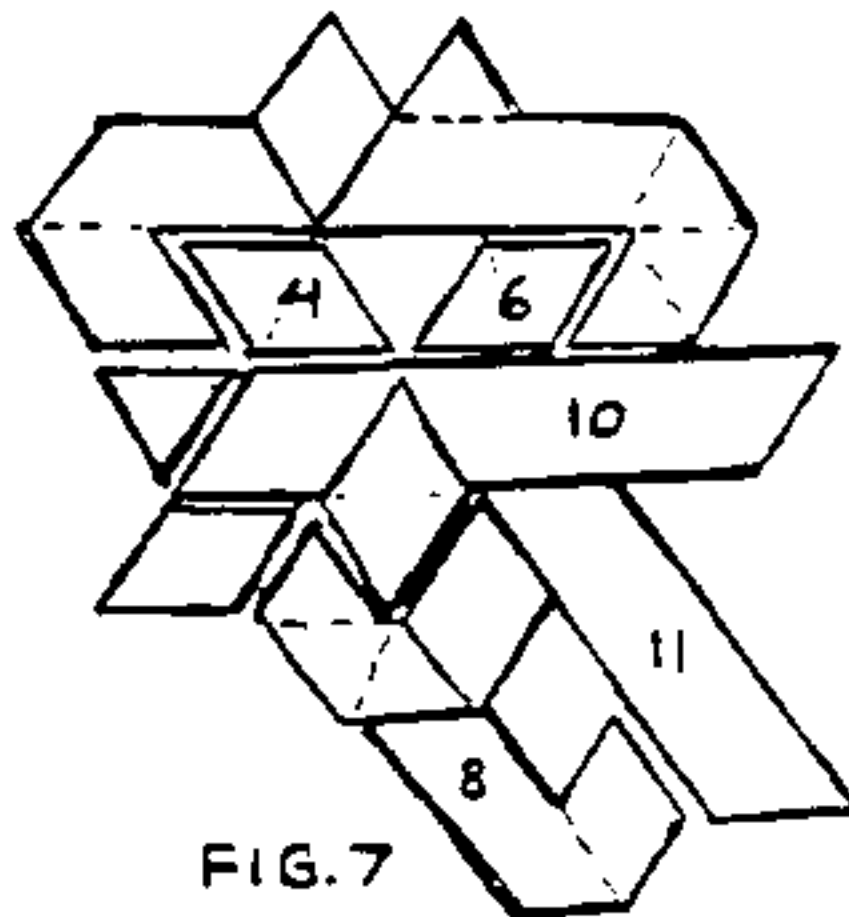

8. Insert key piece 12 to complete the assembly.

Disassembly follows this same procedure exactly in reverse, at least until pieces 8 and 9 are removed, after which the other pieces fall easily apart.

FIG. 7

FIG. 6

# Appendix

## Woodworking Techniques

In this section, we will discuss in greater detail some of the woodworking techniques useful for producing puzzles described in *Puzzle Craft*.

### Lumber

Satisfactory puzzles can be made from a wide variety of woods that are readily available from lumber yards. Clear white pine is easy to work, but it is too soft for hard use; also its pitch tends to gum up your saw and sander. Southern yellow pine is harder and has attractive grain. Poplar is soft and easy to work but does not have an attractive finish - I use it often for experimental work. Douglas fir is inexpensive and readily available, but try to find boards with growth rings close together and free of knots. If your local yard sells "mahogany," it is probably Philippine, which is not even a true mahogany, but rather the name given to a variety of soft, cheap, less desirable species from the Philippines. You can usually find a better selection by going to a millwork shop and buying their leftovers.

After you have acquired some proficiency, you may wish to try some harder and more desirable woods such as walnut, cherry, oak, or birch, to name but a few. For puzzles in which you want two contrasting woods, light and dark, birch and walnut make a good combination. Maple is a good light-colored wood, although its hardness makes it more difficult to work than some of the others.

For really fancy work, there are the so-called exotic woods such as ebony, bubinga, bocote, zebrawood, and many others. My favorite is Brazilian rosewood, being very attractive, stable, easy to work, and readily available (or at least it was when I used it). You will find mail-order suppliers of these woods with ads in woodworking magazines. One of the oldest and best known is Constantine's, 2050 Eastchester Road, Bronx, NY 10461.

I first became interested in these exotic woods when I needed woods of distinctly different contrasting colors, such as in the Four Corners Puzzle. The following are suggestions for different colors of wood: Light - limba, primavera, holly, birch, basswood. Yellow - satinwood, Osage orange, mulberry, difou. Reddish - padauk, peroba rosa, bubinga, Honduras rosewood, cherry. Dark - Brazilian rosewood, walnut, benge. Greenish - poplar, sumac. Purple - purpleheart. Striped - zebrawood, locust. Over the years, I have used over one hundred different kinds of woods in this work. I used to buy wood samples from the International Wood Collectors Society to check out the various colors and grain patterns.

One of the most popular of my production puzzles was the Jupiter Puzzle, shown on the cover but not described in this edition, which required six

contrasting woods. There were others, too. The Design No. 72 on the cover uses ten different woods. With projects like these, one tends to become a seeker and collector of rare and exotic woods. This is a fascinating subject in itself that we will not go into here, except to relate the following anecdote:

For years I had been looking for a wood with bluish cast. I had heard of such a wood called blue mahoe from the island of Jamaica. Inquiries to the Chamber of Commerce there revealed that it was in scarce supply and that its export was embargoed. Then one day while scouting around with a flashlight in the dark and musty waterfront warehouse of a lumber importer in Brooklyn, New York, I chanced to stumble upon a mysterious and long forgotten large stack of sawn veneer. I broke off a sample which, when cleaned off, proved to be of a beautiful bluish hue. I sent it to the USDA wood laboratory in Madison, Wisconsin, for identification. Sure enough, it proved to be blue mahoe! I immediately ordered the entire pallet load, and it was delivered by truck a few days later. Alas, most of it proved to be English brown oak, and much of it too rotten to use. Some I did use to advantage, the box shown on the cover being made of E. B. oak. As for the small quantity of quarter-inch sawn veneer of blue mahoe, I think it was perhaps the most beautiful wood I have ever worked. Most of it went into boxes and trays. It was all book-matched, so I was able to glue the veneers back together to make thicker boards, with the glue lines being practically invisible. About half a dozen of my best Jupiter puzzles were made using this lumber, combined with some especially greenish sumac, blood-red breadnut, and other choice woods. The moral of this story is to keep your eye out for colorful woods. They can turn up almost anywhere, even in shipping crates.

For most puzzle projects requiring only one kind of wood, my favorite is Honduras mahogany. It is quite stable, easy to work and glue, and takes a beautiful finish. The last I knew, it was still in fairly plentiful supply at reasonable prices. Of the domestic woods that are readily available, my favorite is cherry. I have used those two woods more than all others combined. Rosewood would be third.

Whatever wood you use, make sure it is well seasoned and dried before you use it. Most commercial lumber is kiln dried, although several years of air drying may be acceptable. The lumber may be on the damp side coming directly from the lumber yard, so dry it out in your home or shop before using. This all has to do with accuracy of fit.



## Planing the Lumber

Unless you have access to a good thickness planer, you will want to buy your lumber already planed smooth on both sides, which is the way most choice lumber is now sold anyways. The most common is "one-inch" lumber planed to approximately 3/4-inch thickness. This is satisfactory for making many of the puzzles in this book. For some, a thicker board is more desirable, especially a one-inch thickness. Most lumber yards will plane lumber to your specifications. Although thickness planers can be set up to plane with great accuracy and uniformity, the operators of these machines are not accustomed to working to such accuracy, nor do they have any means of measuring thickness accurately. One way around this is to have the lumber planed slightly too thick and do the final milling yourself. Note also that the exact thickness is not important at this stage. All other dimensions can be scaled up or down to suit it. The main consideration is that it be uniform.

For measuring thickness, you will need at least a set of vernier calipers. Dial calipers are better, and if you are really serious, use a micrometer. Bear in mind when measuring lumber fresh from the yard that it will be a few thousandths less when dried.

## Dealing with Warp

This is a major problem. All lumber is warped. It is just a question of how much and which way. There are basically three types of warp - crosswise, lengthwise, and twist.

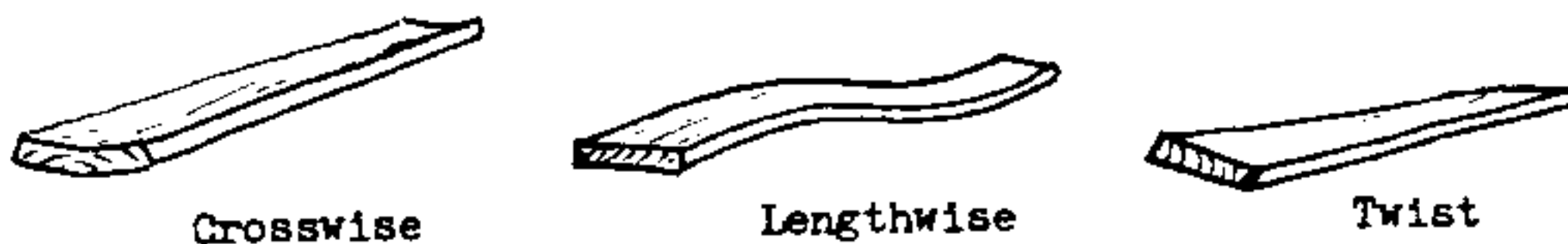

Of these, twist is the worst, and if it is very noticeable, you may as well not use that particular board. Lengthwise warp can be tolerated if not too severe, but it can cause inaccuracies in thickness when planing. Reverse curves are the most troublesome, but sometimes they can be minimized by judiciously cutting the board into shorter lengths. When warped crosswise, which practically every board is unless quartersawn, usually the thickness planer presses it flat while planing so that it emerges from the planer nearly as warped as when it went in. This can be corrected by first running one side over a wide jointer to make it flat and then planing the other side in the thickness planer. This is possible only if the lumber is sufficiently thick

to begin with, and even then it may not be worth the bother, as the board may warp again later.

After the lumber is planed to specifications, cut it into convenient lengths of around three feet, stack it in a pile with alternate sides facing up, and place heavy weights on it to reduce the warp, or at least prevent it from increasing.

With all of these precautions, warp can still be a problem. Some types of wood are much more prone to warp than others. Most of the domestic hardwoods are bad. At the other extreme, most of the dense, oily (and of course expensive!) tropical woods such as teak, padauk, and rosewood are excellent. But beware of zebrawood. Mahogany is a good compromise. Bear in mind, though, that there can be considerable variation even within a species, and that even the most expensive woods can produce boards that are hopelessly warped and useless for this work. Do not waste your efforts on them. Better to use a board of some common wood that is true and flat.

## **Ripping**

Now at last hopefully having some reasonably flat boards of some specified thickness at our disposal, the next step is to rip them accurately into usable sticks. The great majority of the puzzles in this book are made from square sticks, so we will concentrate on that.

Making uniform, accurate square sticks is by no means as easy a task as one might suppose, but it is essential for successful puzzle making. Careful attention to accuracy and uniformity at this stage will save much trouble later on.

If your lumber is virtually free of warp, if you have a good table saw with sharp blade of a type suitable for ripping and long, straight rip fence, set up and adjusted just right, then *perhaps* you can rip out accurate square sticks directly in one operation. Usually not all of these conditions are met, and so the alternative is to rip them out slightly oversized and then plane them down to exact size.

Note: If you intend to mass produce puzzles, then you may wish to have one table saw set up just for ripping. Mine is equipped with a narrow kerf carbide blade designed especially for ripping. It also has a steel plate mounted directly behind the blade the same width as the kerf, which helps to guide the work straight and prevent pinching in on the trailing side of the blade. This is especially useful for certain difficult woods such as zebrawood, which have internal strains and tend to twist every which way when ripped into strips. Otherwise, I recommend you avoid using such woods. Note also that a large bandsaw, suitably equipped with a good sharp blade set at maximum tension, can also be used for roughing out sticks, especially for larger sizes, really hard woods, and those where you must minimize waste.

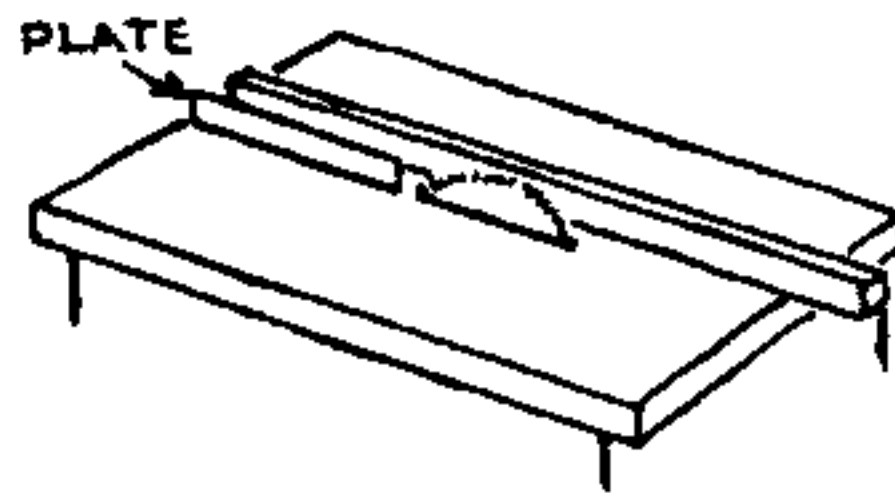

## Planing the Sticks

If the square sticks have been roughed out slightly oversized, the final operation on them is to mill them down to exact size. This is done with a thickness planer. Since most thickness planers are designed to plane wide boards, I built my own small thickness planer designed to dress only small sticks. It consists simply of a portable power plane with front shoe removed, mounted securely over an adjustable flat bed, as shown below.

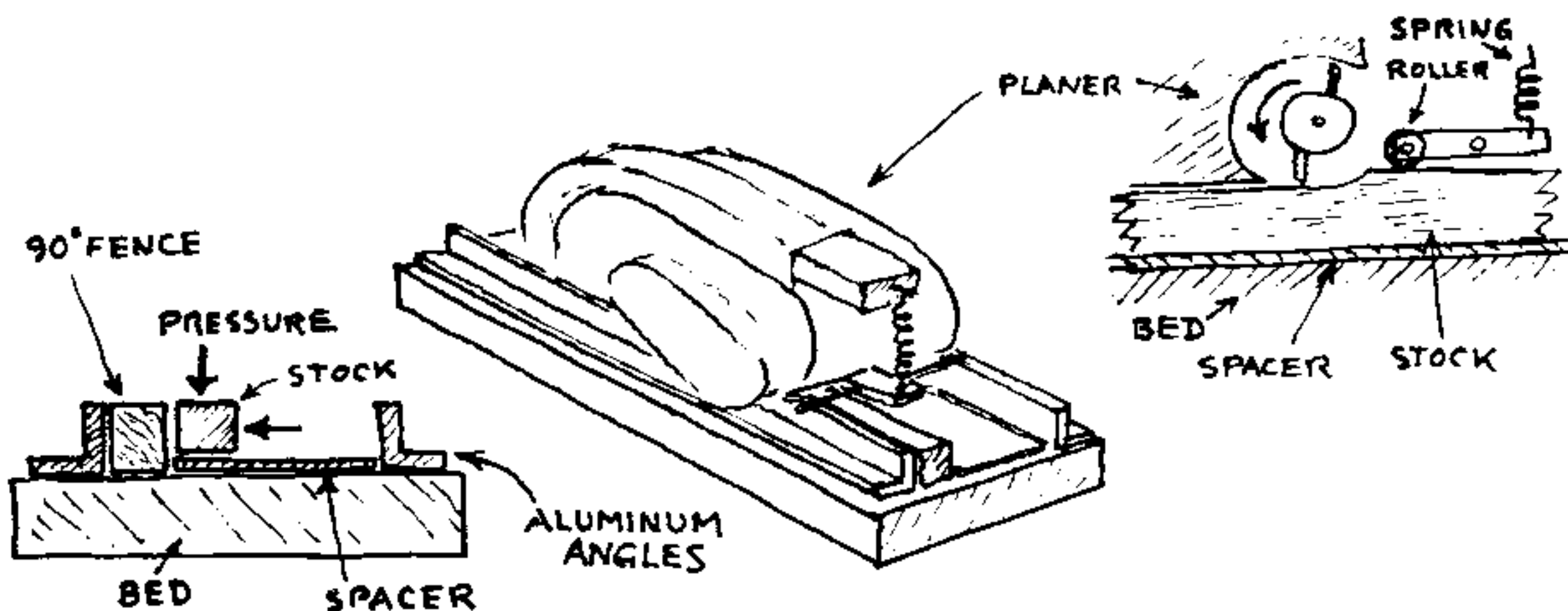

To make one-inch square sticks on this wonderful machine, we start with sticks about 1/16-inch oversized. On the first pass through, the top surface is planed smooth. On the second pass, the stick is rotated 90 degrees counterclockwise, and the planed surface is pressed hard against the vertical left-hand fence, thus assuring a right angle edge. The bed is then adjusted upward slightly by inserting the appropriate shim spacers underneath the stick, so that the final two passes produce an accurate square stick.

As a practical matter, most readers probably do not wish to build their own thickness planer just to make a few puzzles. The alternative is to use an ordinary thickness planer. But be careful that the roller pressure of a large machine does not compress your little sticks. Several sticks can be fed

through at once in parallel, but when doing this, make sure that the knives are set at the same height all across the bed. Note also that there is a minimum size of board that can be safely planed in a large thickness planer without it being thrown back at you!

Most shop planers are equipped with knives ground for planing softwoods. Hardwoods are in general more difficult to plane, some of them notoriously so. The common complaint is gouging and splintering of the surface. This has to do with the type of wood, direction of grain, feed speed, speed and sharpness of the cutter and the angle at which it is ground. If you have no control over the sharpening of the knives, then your alternative is to avoid difficult woods such as bubinga, zebrawood, or purpleheart, or almost any hardwoods with erratic grain.

### **Drum Sanders**

These problems with planing difficult hardwoods can be avoided by using a drum sander instead of a planer. It is claimed that they can produce just as accurate results as a thickness planer. But this would be only if using a large professional sander, not the type likely to be found in the home shop. Bear in mind also that any sanding at this stage will imbed the surface of the wood with tiny bits of grit, which will have a dulling effect on cutting tools in all subsequent operations.

### **Cross-Cutting**

The final sawing operation is usually to cross-cut these long sticks into various usable blocks. For this, one uses a table saw equipped with a suitable blade and various special jigs. I have used a special fine-tooth cross-cutting carbide blade for this, but the blade I prefer is a high-speed steel, 150-tooth, alternate bevel, hollow ground blade. Your local hardware store may carry a hollow ground "plywood" blade, which is a less expensive version of the same thing. The term "hollow ground" indicates that the teeth have no set. These blades, when sharp, produce a smooth cut requiring practically no sanding. Unfortunately, they get dull quickly and must either be sharpened or discarded at the first sign of dullness. Avoid woods such as teak which have a notoriously extreme dulling effect. A dull saw will not cut accurately, and the first sign of dullness may be slight inaccuracies of cut. Other telltale signs are resistance to cutting, noise, and burn marks.

The key to this whole operation is an assortment of suitable saw jigs which you make. They allow you to make repetitive cuts to produce uniform, accurate blocks without the uncertainties of measuring and marking. Some of these have already been described, but here we will show them in greater detail.

## The Square Block Jig

This is one of the simplest and most useful jigs. It is used for sawing cubic or rectangular blocks from square stock. A piece of plywood and long straight board serve as the body and back of this jig. They slide back and forth in the miter grooves of the saw on a pair of runners to which they are firmly attached exactly at right angles. A couple of blocks attached at the right-hand end form a sort of pocket.

Let us suppose you wish to saw out a number of 4-inch long blocks from one-inch square stock, such as might be used for the Six-Piece Diagonal Burr. First you carefully make one block exactly 4 inches long. Place this block in the pocket against the stop at the right-hand end. Now using this block as a stop, saw a second block. If the distance from the saw to the original stop is  $X$ , then the length of this new block is  $X - 4$ . Place this new spacer block in the pocket. Now you are ready to saw as many blocks as you wish, exactly 4 inches long. Label the spacer block for future use. The thumb screw allows for slight adjustments, such as might be necessary when changing saw blades. Make the distance  $X$  slightly longer than the longest block to be sawn - say about 6 inches.

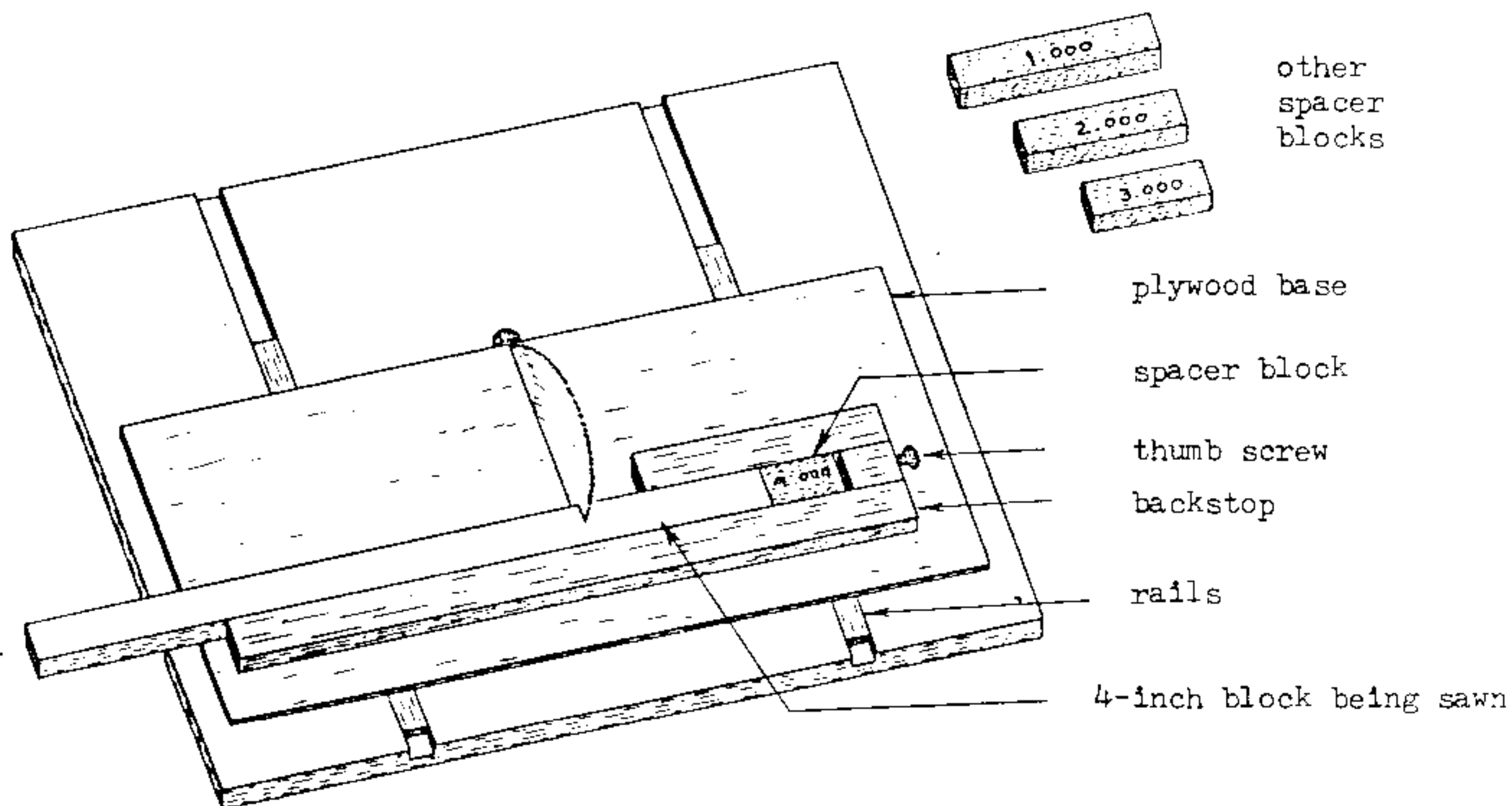

## The Diagonal Jig

This jig was already shown and described on page 36. Shown below is the slightly modified version of it, with end block and spacer blocks added, for making the twelve-sided blocks (rhombic dodecahedra) used in the Four-Piece Pyramid Puzzle and Octahedral Cluster Puzzle (see page 43). Note that this same jig can be used for making blocks of different size simply by using the appropriate sized stock with corresponding sized spacer blocks. With end block removed, it becomes the regular diagonal jig.

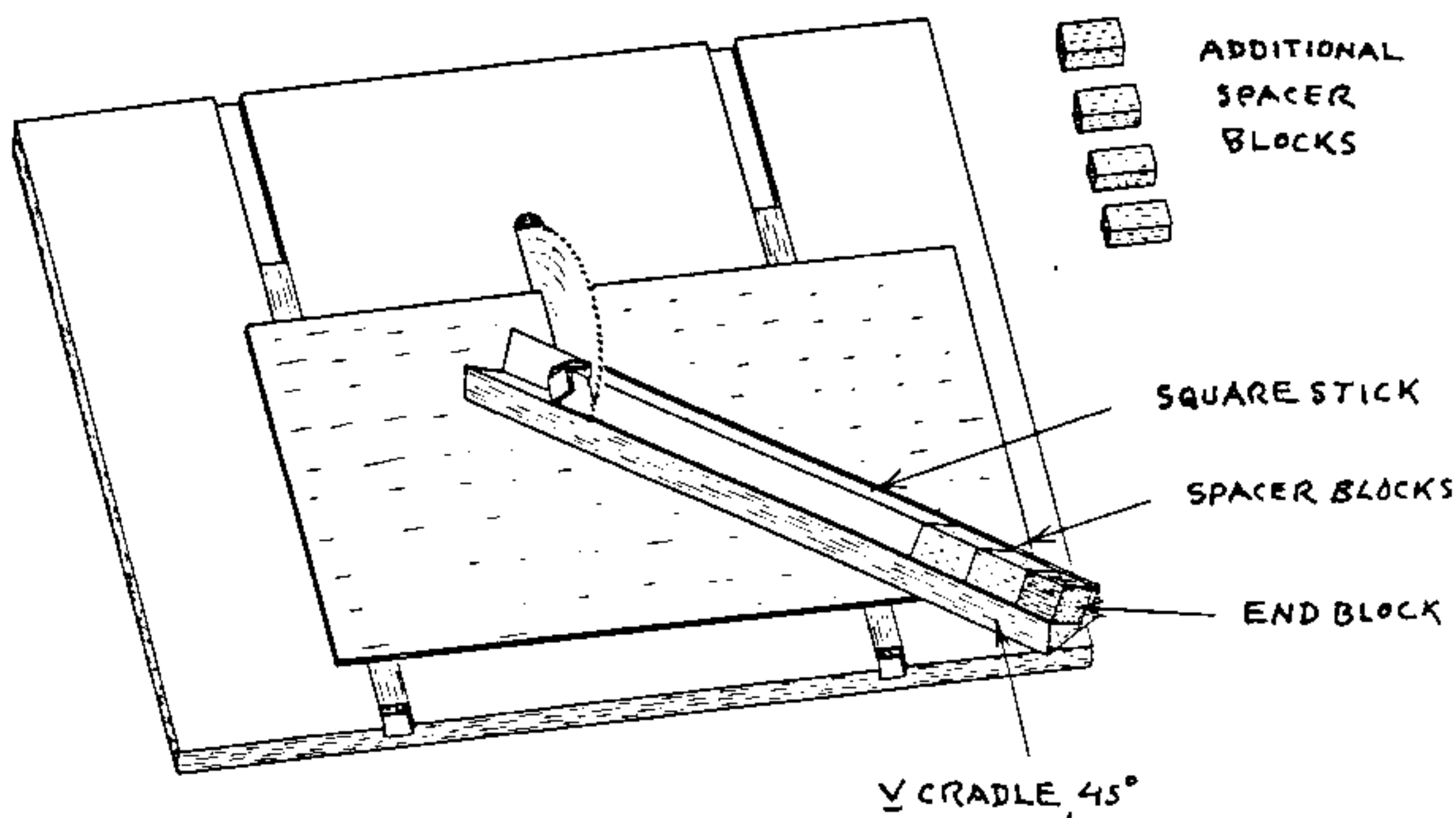

## Making Triangular Sticks

Several of these puzzles use stock of triangular cross-section. Some are an isosceles right triangle, some are equilateral, some are 30-60-90-degrees, and some are otherwise. These can all be ripped out directly on the table saw, or even a bandsaw, but they may not be as accurate or as smooth as you might wish. Nearly the same technique as was described for making accurate square sticks can also be used for finishing these triangular sticks, by feeding them through a small thickness planer (or drum sander), except that now a special insert is needed to hold them. Shown on the next page is the special insert I use in my little thickness planer for making the final dressing on equilateral triangular stock for the Twelve-Piece Separation Puzzle. The same technique would apply for other shapes used in other puzzles.

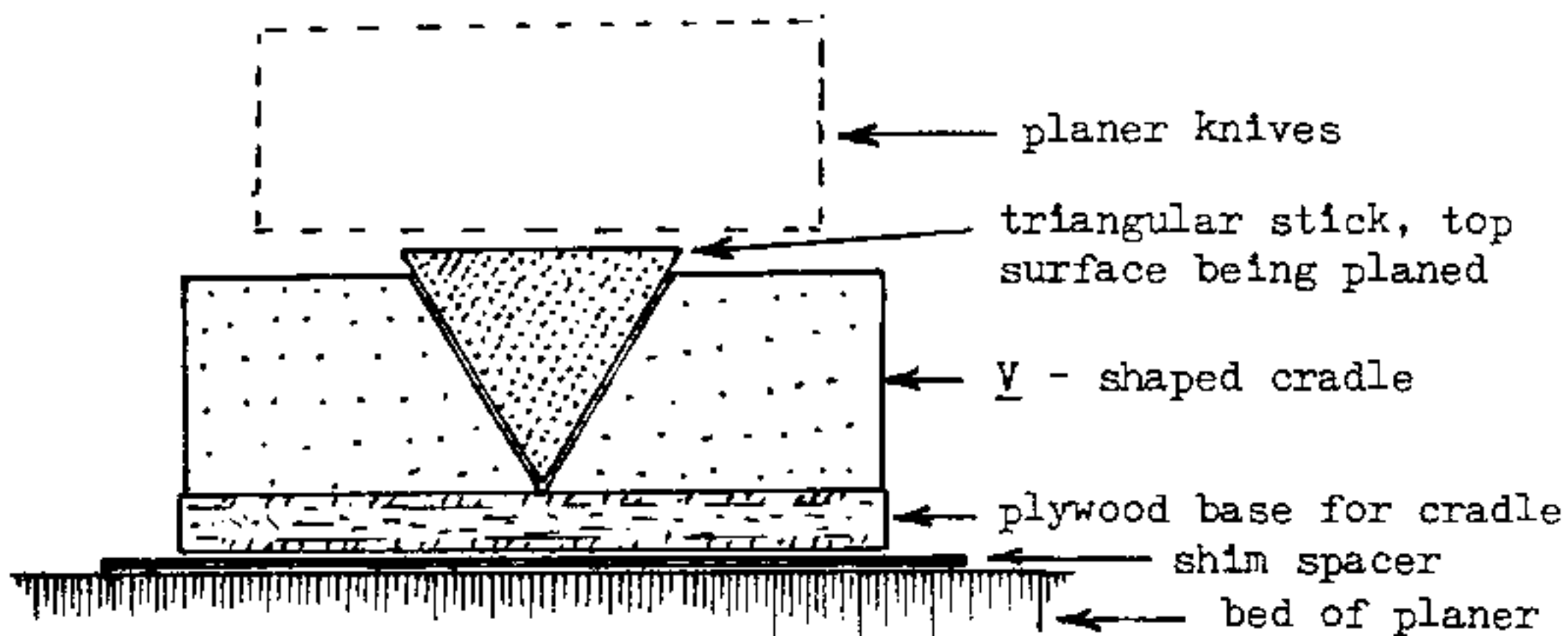

### The Triangular Block Jig

This special jig is used to saw the triangular sticks and end blocks used in the Twelve-Piece Separation Puzzle, not to mention numerous other puzzle designs based on this same geometry. As shown below, its construction follows the same general plan as for the diagonal saw jig. In this case, however, the angle of feed viewed from above is  $54\text{-}3/4$  degrees.

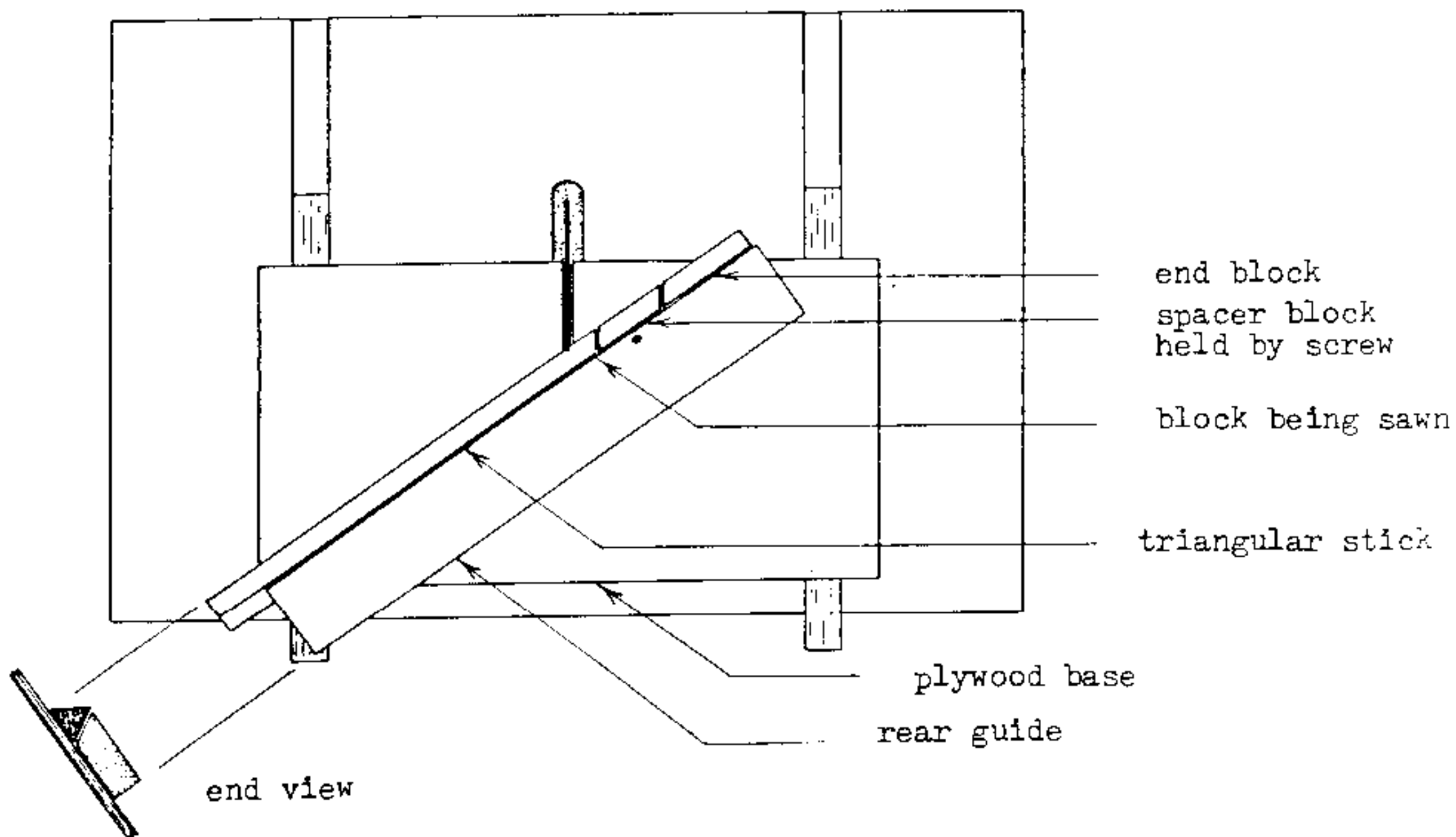

## The Notch Jig

This jig allows you to make square notches, such as for the Six-Piece Burr, easily and accurately. It is used in conjunction with a dado blade in the table saw, set for a width of one-half inch (or whatever dimension you choose). It is but a slight variation of the square block jig on page 67. The four spacer blocks are in half-inch increments. The slot into which the puzzle pieces are dropped is exactly one inch wide, so oversized pieces will not go.

Note that part of the carbide dado blade is shown for clarity. In practice, it can be completely shielded by an extension of the jig, for safety. This applies to other saw jigs also. Otherwise, wear goggles and take suitable safety precautions.

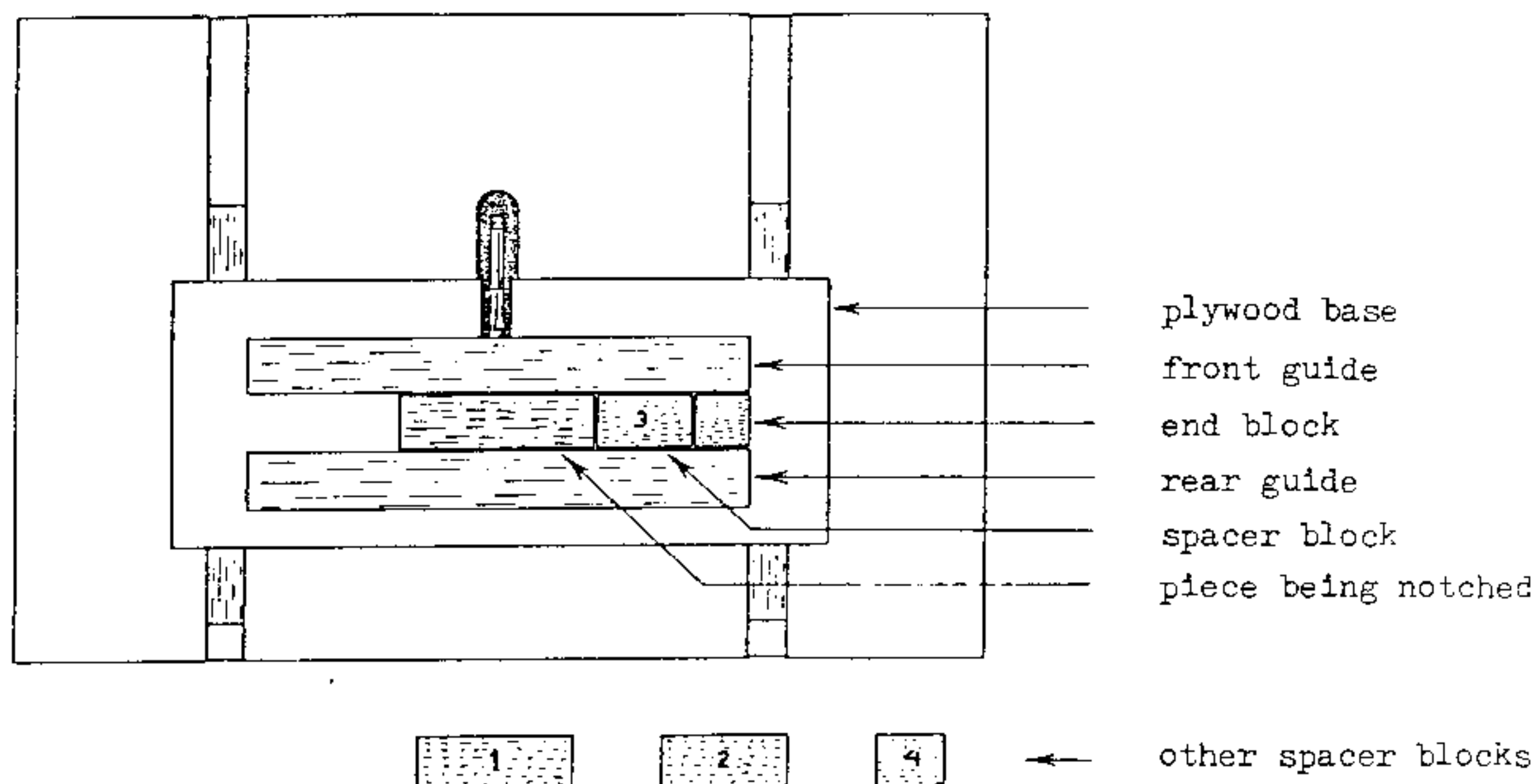

## Trapezoidal Notches

Non-rectangular notches, such as for the Square Prism Puzzle, are a bit more troublesome. I saw them in three steps. First the two diagonal sides are cut on the table saw using a special jig to hold the piece at an angle as shown on the next page. Then the center is chipped out with the dado blade. By the way, when using this method, the adjustment of the two saw cuts is critical. A shift of only a few thousandths of an inch can change the puzzle from too loose to too tight.



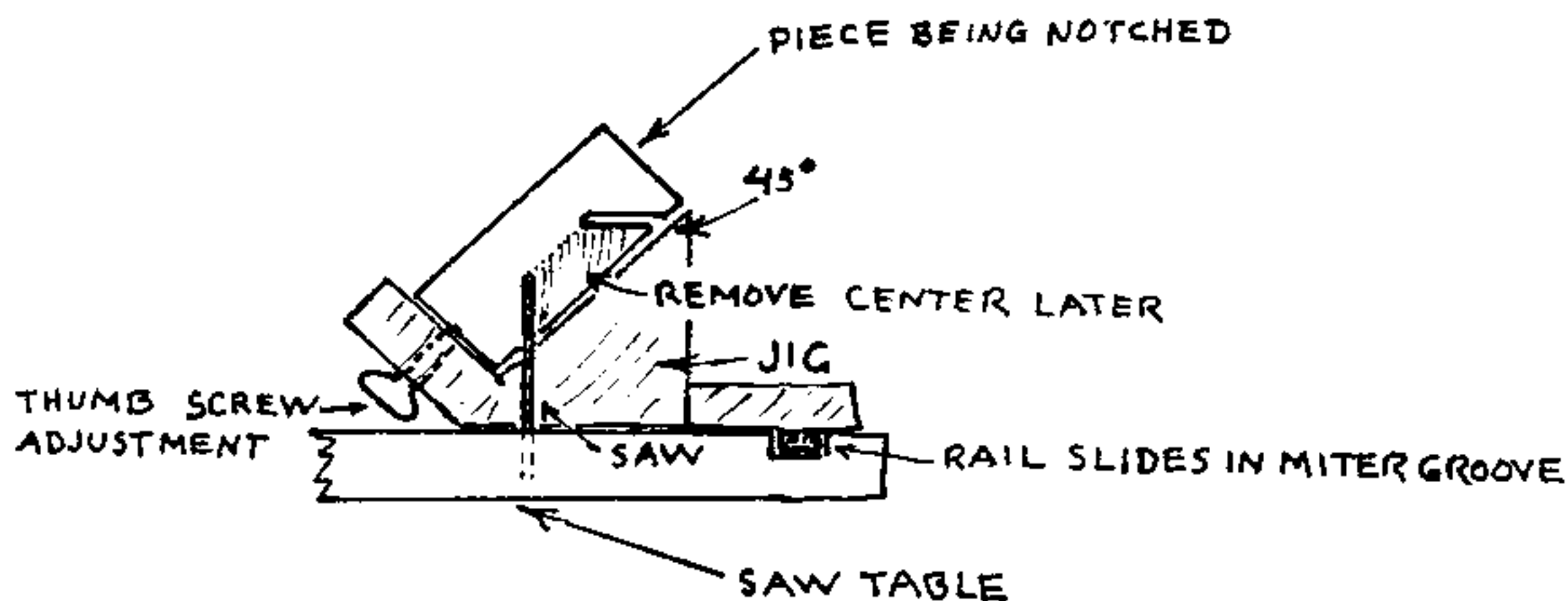

## Drilling Holes

Some of these puzzles require the accurate drilling of clean holes. This can be done on an ordinary drill press, using fixtures of some sort to position the blocks accurately. Ordinary twist drills are designed for drilling metal. They do not do a good job in wood, since they tend to wander about and do not make a clean hole. You need a spur bit. You can buy these in a woodworking store, but you may not find exactly the sizes you want. In that case, you can reduce your dowel stock to accommodate your drill size, or you can try grinding an ordinary twist drill to a spur point (or get some machinist to do it for you).

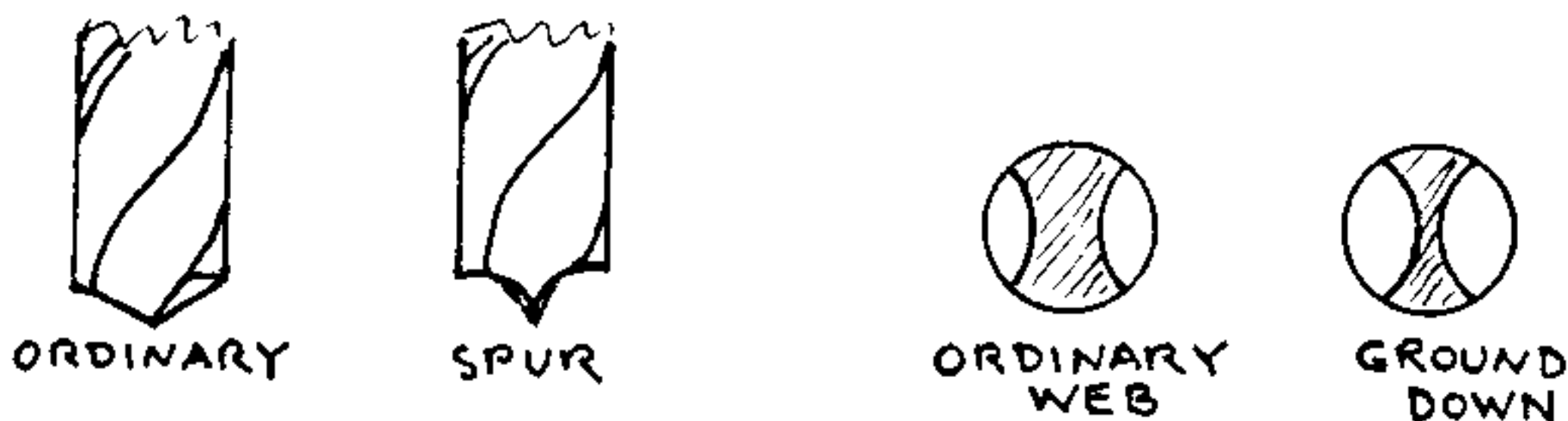

## Gluing Jigs

Most of these puzzles require the gluing together of blocks to form puzzle pieces. One does not simply bring two blocks together with a dab of glue and a touch of hope and faith. To achieve the required accuracy, they must be mechanically aligned and held while the glue sets. At the very least, you will need a flat surface, such as a plate of glass, and a straight edge for making those in Chapters 2 and 3. These work surfaces may be waxed to prevent glue from sticking, or you may use waxed paper.

If you intend to make many of the same kind of puzzle, it may be worthwhile to devise special jigs to hold the pieces accurately while gluing. Some of these have already been described. In the case of interlocking puzzles, most of them are glued in the assembled or partially assembled state, as this assures a close fit. For puzzles like those in Chapters 8 and 10, the first puzzle accurately made and well waxed serves as a gluing jig for the next.

For some of these polyhedral puzzles, making an accurate gluing jig is the most critical and difficult part of the whole process. My Jupiter Puzzle, shown on the cover but not included in the text of this edition, is but one example of this. The pattern for my gluing jig was made by a skilled machinist using a Bridgeport milling machine with rotary table, surely beyond the means of most woodworkers. One alternative for the casual woodworker, however, might be to find one of my old Jupiter puzzles somewhere and use one of the pieces to cast a molded jig in plaster of Paris. (For those interested, a description of this puzzle may be found in *Puzzling World*.)

## Gluing

For all puzzle work, I recommend aliphatic resin (yellow) glue, such as Franklin Titebond or Elmer's Professional, sold in all hardware stores. It is easy to use, non-toxic, reasonably fast setting, and forms a sufficiently strong bond with most woods. It will not fill voids of poorly fitting joints as will epoxy. It has little initial tack as does contact cement. It is not waterproof. It does have a slight amount of give, so joints are not likely to pop apart with changes in humidity.

Some woods are ever so much easier than others to glue. The medium-hard domestic hardwoods such as birch or cherry form an almost instant bond. Walnut, oak, maple, and basswood all bond well too. The dense, oily woods like rosewood and satinwood may eventually form an adequate bond, but with setting times of hours rather than minutes. The process can be speeded up considerably by warming the blocks for an hour or two before gluing. This also helps to drive off excess moisture. The very oily woods like cocobolo and teak do not make a strong bond, although it is claimed that this can be improved by first cleaning the surfaces with a solvent such as acetone. When certain very hard woods such as Osage orange or locust are sanded with a worn belt, they can acquire a shiny glazed surface almost impossible to bond to. The remedy for this is to remove the glaze with medium sandpaper.

Very soft porous woods such as poplar and Philippine mahogany present a contrary problem, especially when gluing on the end grain, as the glue can just soak in and disappear. These require a heavier spread of glue, left open for a minute or two, and then brought together gently. Or apply a

preliminary sealer coat before gluing. It helps if the end grain surfaces are sawn with a very sharp saw or sanded lightly before gluing.

A post mortem of failed glue joints has revealed that in many cases the two surfaces did not mate properly to begin with, so that as the glue dried and shrunk, air pockets formed.

Occasionally it is desirable to take the extra pains to dowel the joints. The easiest way to do this is to first glue the pieces together in the usual way. Then drill in from a side that does not show, squirt some glue into the hole, and insert a 1/8-inch dowel. This can be done on the Three Pairs Puzzle. On others such as the Four Piece Pyramid Puzzle, where there is no hidden side from which to drill, the dowels must be set in while gluing, and this is very tedious work.

### **Sanding**

For the sake of appearance, practically all of these puzzles will benefit from a final sanding before applying the lacquer finish. Some of them, such as the Corner Block Puzzle, are entirely convex when assembled. Thus they can be sanded after assembly using a belt sander. On others, such as the Cornucopia, at least the top and bottom faces can be sanded after assembly. On puzzles like the Joined Pairs Puzzle, it is obviously much easier to sand the sides of the stock before it is sawn into blocks and glued, but take care to do it gently so as not to destroy the accuracy. The final sanding can be with #220 grit.

With some puzzles, such as the Four Corners Puzzle, careful sanding of the two outside longitudinal sides of each piece may be necessary to achieve just the right fit.

For a final touch, break all sharp edges and corners with fine sandpaper. On some puzzles, such as the burrs for example, I think a better effect is to carefully bevel the edges at 45 degrees with a file.

### **Finishing**

Nearly all of my puzzles are finished by applying clear lacquer with an artist's camel hair brush. It is thinned at least 1:1, or even 2:1, so that it is more of a penetrating sealer rather than a coating. The big advantage of lacquer over all other finishes is that it dries fast and gives satisfactory results on all kinds of wood. No other finish that I have tried does that. If you want to experiment, you may find that certain other finishes give satisfactory results on certain woods. For example, some oil finishes work well on mahogany and cherry, if you have the patience to rub them in and let them dry thoroughly.

You can follow that up with waxing and buffing if you wish. Use any common wax such as bowling alley paste wax. Avoid excessive use of wax

on porous woods, because it can dry to an ugly chalky white. Good old lemon oil with beeswax furniture polish is a better choice on such woods. Some dense, oily exotic woods such as ebony do not require any finish at all, and others such as rosewood need only waxing and buffing. Some puzzles, such as the Fourth Dimension Puzzle, require a smooth sliding action of the parts to be satisfactory, so the mating surfaces should be waxed and polished.

Old puzzles can be cleaned and restored using these same techniques. It may be desirable to first clean them with fine sandpaper or fine steel wool before applying the new finish.

## **Dealing with Expansion and Contraction**

All woods expand and contract with changes in humidity. If this were uniform in all directions, there would be no problem, but that is far from the case. It is greatest along the growth rings (tangential), less across the growth rings (radial), and much less along the grain. Consequently, nearly all interlocking wooden puzzles become too tight when humid and too loose when dry, although a few do just the opposite. This is a very serious problem for the puzzle maker, and there are no easy solutions.

First of all, no type of finish coating, such as lacquer, varnish, shellac, or whatever, no matter how many coats applied, is going to do much good, so dismiss that idea.

Since some woods are much worse than others in this respect, the obvious remedy is to use only the more stable ones. As you might expect, these tend to be the most exotic and expensive tropical woods, with the common domestic hardwoods being the worst. There are tables in wood engineering handbooks with this information. I once took careful measurements on samples of some of the multitude of woods I worked with at high and low humidity, from which I report the following:

- Best - cocobolo, padauk, teak, African blackwood
- Very good - Brazilian rosewood, tulipwood, ebony, breadnut
- Good - Honduras mahogany, koa, limba, primavera, satinwood
- Fair - ash, walnut, bubinga
- Poor - birch, cherry, maple, beech, hickory, oak

In this list, Honduras mahogany stands out as the one good wood that is reasonably priced and readily available. It was also mentioned as being relatively free of warp. It is easy to saw, sand, glue, and finish. I use it more than any other wood. Its one fault is that it does produce an irritating dust when sanded.

Since some puzzle configurations are more susceptible than others to changes in humidity, we might try to avoid the worst and emphasize the best. I have already done that to some extent. The Diagonal Six-Piece Burr Puzzle and its near relatives are the worst in this respect. Puzzles that

come apart in one order only, such as the Convolution Puzzle, and puzzles that come apart along one axis only, such as the Pennyhedron and Burr 305, tend to be less affected than those which come apart many ways.

One practical scheme is to arrange the blocks with their grain all running in the same direction, resulting in nearly a complete cancellation of ill effects. This was recommended for the Five-Piece Solid Block Puzzle, the Three-Piece Block Puzzle, the Four-Piece Pyramid Puzzle, and the Octahedral Cluster Puzzle.

For non-interlocking puzzles, where the parts just pack into a box or tray as in the first three chapters, humidity is not much of a problem.

## **Hazards of Woodworking**

The most obvious hazard is cutting one's fingers on a saw or other power tool. We must assume here that the reader already has some familiarity with safety in the shop and has read the power tool instructions. Proper design of the sawing jigs will minimize the chances of one's fingers even coming close to the saw blade. Most blocks are made by sawing off the end of a long stick. Discard it when it becomes too short to saw safely. When making notches with the dado blade, the blade can be shielded almost completely by the jig and the piece being notched. The thickness planer knives are completely hidden.

I have never known of a circular saw blade to shatter or throw off a tooth but nevertheless I do consider it a possibility. I try to design my saw jigs with shields built in to guard against this and also bits of wood being thrown up. Otherwise, use a face mask.

Breathing any kind of dust in large amounts is probably unhealthy. I use a dust collection system with my sander and most other power tools, and sometimes I wear a dust mask besides. The dust of certain woods is especially objectionable, and it is best to avoid using them. I recommend for a start avoiding cocobolo, makore, and mansonina altogether. Rosewood, padauk, satinwood, and some mahoganies produce an irritating dust, and so you may wish to wear a mask when sanding them. Different individuals react differently to different woods.

Another good reason for disposing of dust and shavings is that they constitute a fire hazard. I have known of many woodworking shops destroyed by fire. Almost any power tool has a switch that can produce sparks, and many woods strike sparks when sawn. A smoke detector and alarm for your shop is a good idea.

The glue I use and recommend is non-toxic. You can avoid breathing the fumes of lacquer thinner by using a respirator. Mine is made by American Optical with R51A cartridges for organic vapors.

## **Puzzle Making as a Home Business**

One of the advantages of puzzle making as a home business is that it requires practically no outlay of capital to get started. If you have a home hobby woodworking shop, you probably already have nearly all the power tools you need. Most of the specialized jigs require only the investment of much time and painstaking workmanship. If you like to tinker with mechanical puzzles, then you will probably also enjoy the challenge of devising and accurately making these jigs and specialized tools.

Another advantage is that it does not require much space. Even a 10-inch table saw or 6-inch jointer might be considered oversized for this puzzle work. My basic power tools are two 8-inch table saws, a 20-inch bandsaw, small thickness planer, belt sander, and drill press. Storage of lumber occupies half my shop space.

I regard puzzle making, as I have carried it on for the past twenty years and have attempted to describe in this book, as more of a craft than a manufacturing operation. As a small, part-time home business, for me it has proven to be just about ideal. I have some doubts about wooden puzzle making as a growth industry with hired help, advertising, and all the rest. I have known a few who have tried and failed.

If you want to sell your product, one way to get started is at craft fairs. This is a wonderful way to meet the public and get their reactions to your work, besides being just plain fun to do. Children take to it and love it. The best medium for advertising, and the only one I have used, is where the publisher pays *me* for the ad. I am referring of course to writing articles on puzzle making for woodworking magazines. But watch out - you may soon be swamped with more orders and inquiries than you bargained for!

## **Licensing of Puzzle Inventions**

One of the most frequent inquiries I receive is from someone who fancies himself or herself to be an inventor. They have just come up with a new puzzle idea and are looking for some licensee to manufacture and sell it. Then just sit back and relax as royalties pour in by the millions! Every once in a great while we hear of some such case, just enough to keep our hopes alive. (Rather like winning the lottery sweepstakes.) We tend to forget about the thousands of good ideas that never got anywhere.

Here are some suggestions: Don't pin all your hopes on one invention. Try to come up with many, each one better than the last. Keep trying to improve. Try them out on friends. They are a better judge than you are. You shouldn't have to explain anything. No one is going to do that in the store. Keep careful dated records of your work. Make several models of each invention and consider them expendable. Show them to as many manufacturers as possible. Don't worry that someone is going to steal them. Don't waste money on patents, but a patent search may be

worthwhile provided you do it yourself. U. S. patents are on file in large public libraries all over the country. If your invention is licensed for manufacture, the manufacturer may want a patent application filed, in which case they will pay for it.

How would it be manufactured? You must have some knowledge of manufacturing. What will it cost? A mass produced puzzle or game might be sold at retail for eight to ten times its basic manufacturing cost.

Most successful inventors have a business agent to handle some of these matters. Unless you want to spend all your time traveling around the country on what is probably a wild goose chase, you will need one too. I had one for a while, whose specialty was puzzles and games. He quit the business as being unprofitable, and I do not now know of any others. That was what prompted me to start my own puzzle making business.

Making and selling your own hand-crafted product is much more satisfying than licensing same to a manufacturer whose bottom line is sales and profit, and whose means to that end is production at the lowest possible cost. And you will meet the nicest people too.

## Bibliography

*The Puzzling World of Polyhedral Dissections*, by Stewart T. Coffin, Oxford University Press, 1990 hardbound, 1991 softbound.

*Puzzles Old and New*, by Slocum and Botermans, University of Washington Press, 1986. Ordering information: Jerry Slocum, P. O. Box 1635, Beverly Hills, CA 90213.



## Sources of Puzzles

In the past, whenever I have published a list of puzzle companies, they have shown a definite tendency to move with no forwarding, go out of business, or otherwise not respond to inquiries. This new listing should be more reliable. I include mostly craftsmen known by me to be making good wooden puzzles of the types described in this book. Some of these could best be described as "cottage industries." This may not be their full-time business, and they may have other jobs to support themselves. So do not expect instant response or fancy catalogs in all cases.

Bill Cutler Puzzles, 405 Balsam Lane, Palatine, IL 60067 - foremost expert on burr puzzles, designs difficult ones with the aid of a computer and makes them in his spare time.

Wayne Daniel, P. O. Box 382, Minden, NV 89423 - designs and makes good quality clever interlocking puzzles.

Phillippe Dubois, Pob 9037, 91090 Jerusalem - designs, makes, and sells very high quality polyhedral puzzles.

Charles Gantt, 111 So. Glenwood Ave., Orlando, FL 32803 - a retiree making a variety of low cost wooden puzzles, catalog.

Kadon Enterprises, Inc, Suite 16, 1227 Lorene Drive, Pasadena, MD 21122 - good company, original puzzles and games, catalog.

Jerry McFarland, 770 Love St., Elk Grove, IL 60007 - excellent craftsman, makes clever interlocking puzzles including some of Cutler's.

Pentangle, Over Wallop, Hants SO20 8JA, England - in the business of manufacturing and selling puzzles of all sorts.

Trench Enterprises, Three Cow Green, Bacton, Stowmarket IP14 4HJ, England - maker of many well conceived and crafted wooden puzzles, catalog.

Trevor Wood, 28 Alexandria Crescent, Ilkley, West Yorkshire LS29 9ER, England - makes well crafted box packing puzzles.

(When ordering catalogs from overseas, please include at least enough for postage and handling.)

## The Key

The author of a manual such as this must always wonder, at its conclusion, what will be its destiny? What unknown woodworkers in what distant lands may find it useful for making puzzles as holiday gifts for their children or grandchildren? Will this be the beginning of a life-long fascination with geometrical puzzles and mechanical devices of all sorts, as it was for me many long years ago? Will some woodworking instructor be inspired to start a puzzle project in her classroom for an enthusiastic bunch of youngsters? Or will they all be dismayed by the confusing directions and lack of sufficient detail in some of the drawings, not to mention the inevitable little mistakes and omissions?

Take heart in the assurance that at least this is a vast improvement over previous editions in that respect. Regrettably, I have omitted from this edition some of my favorite designs, such as the Scrambled Scorpius and Rosebud puzzles, either because they are harder to make or harder to describe how to make. For those interested in pursuing this subject further, those and many others are described in my other book, *The Puzzling World of Polyhedral Dissections*. Furthermore, I have kept all old *Puzzle Craft* copy on file, from which selected sections can be photocopied and made available at cost for those interested.

Have you gone shopping lately for children's toys? If so, are you as appalled as I am by the industry's ghastly preoccupation with weaponry and combat, games in which the ultimate object is always to defeat others rather than help them, arcane technology handed down from above, and the overall lack of imagination, vision, inspiration, creativity, and artistic values that pervade and rule the toy and game industry? What we are tinkering with here is more than mere fulfillment of gift obligations or pastimes to keep unruly children occupied. This is the future of the human race. As we drift aimlessly through this vast universe on our lonely little planet, do you suppose there is a better world out there somewhere, waiting patiently for us to find it?

It may be but one small step in the right direction, and even that might be regarded as a self-serving presumption, but for holiday gifts next time, why not consider hand-crafted puzzles. Better still, encourage children to make their own, starting with the simple projects at the beginning of this manual and working upward from there. Finally, and most important of all, encourage them to invent their own new and original designs, following some of the guidelines I have set forth. Let them become enraptured by the fascinating world of geometrical puzzles and pastimes. That is the ultimate object of this little book. Good luck!